

CODE	SIZE	A		B		D		R		Wt	
		[mm]	[inch]	[mm]	[inch]	[mm]	[inch]	[mm]	[inch]	[mm]	[inch]
TE2C6L.5-..	½"	75.69	2.98	42.16	1.66	12.70	.5	28.6	1.13	1.65	.065
TE2C6L.75-..	¾"	75.69	2.98	42.16	1.66	19.05	.75	28.6	1.13	1.65	.065
TE2C6L1.0-..	1"	75.69	2.98	52.07	2.05	25.40	1	38.1	1.50	1.65	.065
TE2C6L1.5-..	1½"	94.74	3.73	71.88	2.83	38.10	1.5	57.2	2.25	1.65	.065
TE2C6L2.0-..	2"	120.14	4.73	91.44	3.60	50.80	2	76.2	3.00	1.65	.065
TE2C6L2.5-..	2½"	139.19	5.48	111.25	4.38	63.50	2.5	95.25	3.75	1.65	.065
TE2C6L3.0-..	3"	158.75	6.25	131.06	5.16	76.20	3	114.3	4.50	1.65	.065
TE2C6L4.0-..	4"	202.69	7.98	173.48	6.83	101.60	4	152.4	6.00	2.11	.083

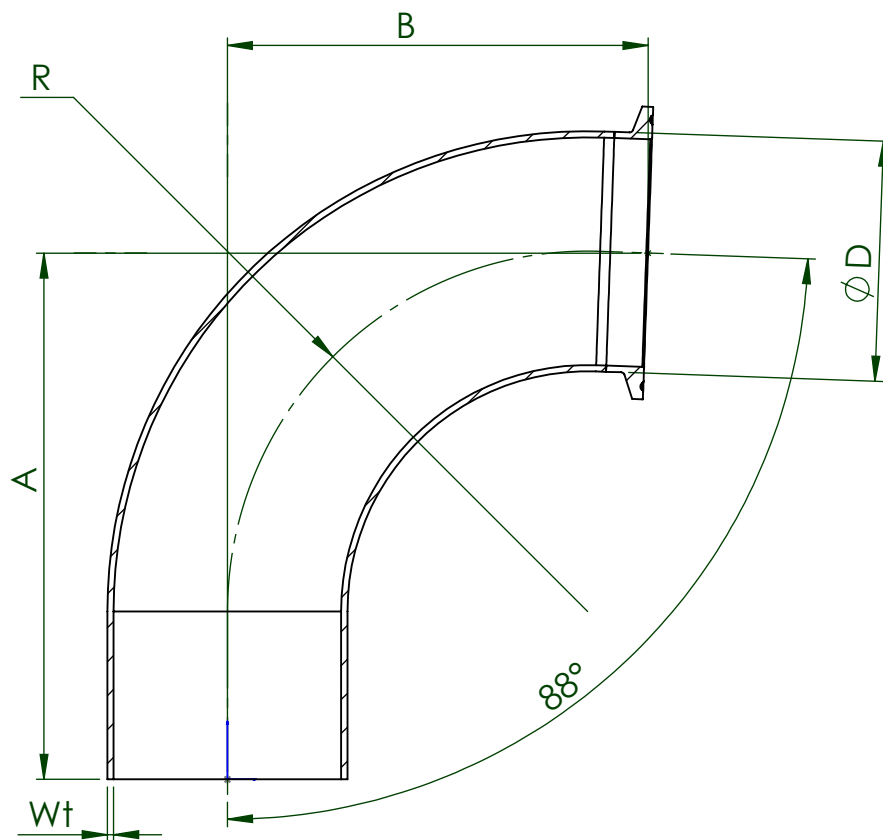

		EGMO LTD. Tanks and stainless steel accessories P.O.B. 1111, 1 Hayotsrim St. 22110 Nahariya Israel Tel. 972-4-9855175 Fax: 972-4-9855173	
Ordering Code: TE2C-92 ELBOW		Drawn Guy.S	4/7/2015
		Approved Alex.L	4/7/2015
		Material: AISI 316L	
©2014 EGMO Ltd. All rights reserved. The information on this drawing may not be reproduced or republished without prior consent of EGMO Ltd		Finish: ASME BPE-2012 (Per ordering)	
		Size - A4	Rev: 0
		Sheet 1 From 1	