



Sterile Sampling Valves

MaxPure Sterile Sampling Valves

The new sampling valve series reduces risk of cross contamination and is suitable for various media types and viscosity.



* Available with clamp or hose barb end connections

Technical Information



BSA1

BSA2

In-Line sterilization	No	Yes
Outlet Angle	60°; 90°	
Dimension	Ferrule: ½"-¾" & 1"-1½" Weld: 1"***	
Sampling Temp. Max.	120°C; 248°F	
Sterilization Temp. Max.	135°C; 275°F	
Autoclave Temp. Max.	121°C / 249.8°F - 40 minute / 134°C / 273.2°F - 20 minute	
Inlet Hole	7mm / .28"	
Materials*	Body: SS316L***, Handle: PA-6 GF30, Orings: Viton®, Stem: 316/PTFE	
Max. Pressure	8 bar; 117 PSI	

* Other materials of construction are available upon request.

** Sizes up to 6" (included) are available.

*** SS316L, BPE SF4 ID 15 Ra + EP, OD 32 Ra + EP

Part Number Configuration







Valve Body	Material Type	Outlet Angle	Body Connection Type**	Sampling Connection Type
BSA1 - Standard Body	6L - 316L	60 - 60 Degrees	TC.5 - Clamp End .5" and .75"	TC.375 - Clamp End Fits .375", .5" and .75"
BSA2 - With Sterilization (SIP) Port*	6MO*** - UNS-N08367 A22*** - UNS-N06022	90 - 90 Degrees	TC1.0 - Clamp End 1.0" and 1.5" TC2.0 - Clamp End 2.0" TC2.5 - Clamp End 2.5" TC3.0 - Clamp End 3.0" TC4.0 - Clamp End 4.0" TC6.0 - Clamp End 6.0" W1.0 - Weld End 1.0"	- 3A Compliant HB.375 - Hose Barb .375" - 3A Compliant HPHB.375 - High Pressure Hose Barb .375"

* The Sterilization port is always a .375" clamp end connection that fits .5" and .75" clamp ends.





** Eccentric body valves are available in clamp end sizes 1" and larger. The body connection type is designated by ECCTC (Size).

*** Special material upon request.



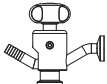

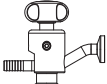

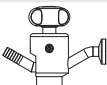
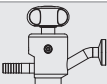
MaxPure A1 Series

Type	Item Number	Name	Description	BSA1
1/2"-3/4" CLAMP 60°	621-00211	BSA1-6L-60-TC.5XHPPH.375	.5" CLAMP SAMPLE VALVE 60 DEG 3/8" HB 316L SF4	
1"-1 1/2" CLAMP 60°	621-00212	BSA1-6L-60-TC1.0XHPPH.375	1.0" CLAMP SAMPLE VALVE 60 DEG 3/8" HB 316L SF4	
1/2"-3/4" CLAMP 90°	621-00213	BSA1-6L-90-TC.5XHPPH.375	.5" CLAMP SAMPLE VALVE 90 DEG 3/8" HB 316L SF4	
1"-1 1/2" CLAMP 90°	621-00214	BSA1-6L-90-TC1.0XHPPH.375	1.0" CLAMP SAMPLE VALVE 90 DEG 3/8" HB 316L SF4	
1" WELD 60°	621-00222	BSA1-6L-60-W1.0XHPPH.375	1.0" WELD SAMPLE VALVE 60 DEG 3/8" HB 316L SF4	
1" WELD 90°	621-00223	BSA1-6L-90-W1.0XHPPH.375	1.0" WELD SAMPLE VALVE 90 DEG 3/8" HB 316L SF4	





MaxPure A2 Series

Type	Item Number	Name	Description	BSA2
1/2"-3/4" CLAMP 60°	621-00207	BSA2-6L-60-TC.5XHPPH.375	.5" CLAMP SAMPLE VALVE 60 DEG 3/8" HB & TC 316L SF4	
1"-1 1/2" CLAMP 60°	621-00208	BSA2-6L-60-TC1.0XHPPH.375	1.0" CLAMP SAMPLE VALVE 60 DEG 3/8" HB & TC 316L SF4	
1/2"-3/4" CLAMP 90°	621-00209	BSA2-6L-90-TC.5XHPPH.375	.5" CLAMP SAMPLE VALVE 90 DEG 3/8" HB & TC 316L SF4	
1"-1 1/2" CLAMP 90°	621-00210	BSA2-6L-90-TC1.0XHPPH.375	1.0" CLAMP SAMPLE VALVE 90 DEG 3/8" HB & TC 316L SF4	
1" WELD 60°	621-00220	BSA2-6L-60-W1.0XHPPH.375	1.0" WELD SAMPLE VALVE 60 DEG 3/8" HB & TC 316L SF4	
1" WELD 90°	621-00221	BSA2-6L-90-W1.0XHPPH.375	1.0" WELD SAMPLE VALVE 90 DEG 3/8" HB & TC 316L SF4	

MaxPure A1 3A Series

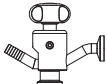
Type	Item Number	Name	Description	BSA1
1/2"-3/4" CLAMP 60°	621-00289	BSA1-6L-60-TC.5XHB.375	.5" CLAMP SAMPLE VALVE 60 DEG 3/8" HB 316L SF4 3A	
1"-1 1/2" CLAMP 60°	621-00290	BSA1-6L-60-TC1.0XHB.375	1.0" CLAMP SAMPLE VALVE 60 DEG 3/8" HB 316L SF4 3A	
1/2"-3/4" CLAMP 90°	621-00291	BSA1-6L-90-TC.5XHB.375	.5" CLAMP SAMPLE VALVE 90 DEG 3/8" HB 316L SF4 3A	
1"-1 1/2" CLAMP 90°	621-00292	BSA1-6L-90-TC1.0XHB.375	1.0" CLAMP SAMPLE VALVE 90 DEG 3/8" HB 316L SF4 3A	
1" WELD 60°	621-00293	BSA1-6L-60-W1.0XHB.375	1.0" WELD SAMPLE VALVE 60 DEG 3/8" HB 316L SF4 3A	
1" WELD 90°	621-00294	BSA1-6L-90-W1.0XHB.375	1.0" WELD SAMPLE VALVE 90 DEG 3/8" HB 316L SF4 3A	

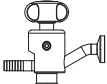

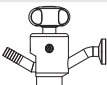
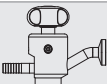

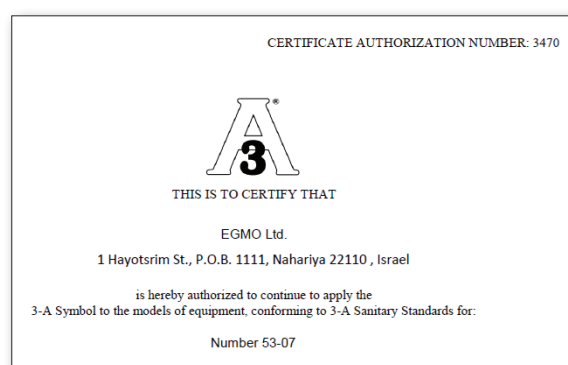

MaxPure A2 3A Series

Type	Item Number	Name	Description	BSA2
1/2"-3/4" CLAMP 60°	621-00295	BSA2-6L-60-TC.5XHB.375	.5" CLAMP SAMPLE VALVE 60 DEG 3/8" HB & TC 316L SF4 3A	
1"-1 1/2" CLAMP 60°	621-00296	BSA2-6L-60-TC1.0XHB.375	1.0" CLAMP SAMPLE VALVE 60 DEG 3/8" HB & TC 316L SF4 3A	
1/2"-3/4" CLAMP 90°	621-00297	BSA2-6L-90-TC.5XHB.375	.5" CLAMP SAMPLE VALVE 90 DEG 3/8" HB & TC 316L SF4 3A	
1"-1 1/2" CLAMP 90°	621-00298	BSA2-6L-90-TC1.0XHB.375	1.0" CLAMP SAMPLE VALVE 90 DEG 3/8" HB & TC 316L SF4 3A	
1" WELD 60°	621-00299	BSA2-6L-60-W1.0XHB.375	1.0" WELD SAMPLE VALVE 60 DEG 3/8" HB & TC 316L SF4 3A	
1" WELD 90°	621-00300	BSA2-6L-90-W1.0XHB.375	1.0" WELD SAMPLE VALVE 90 DEG 3/8" HB & TC 316L SF4 3A	

Conforming to 3-A Sanitary Standards for No. 53-07.
CERTIFICATE AUTHORIZATION NUMBER: 3470



MaxPure A1 3A CC Series

Type	Item Number	Name	Description	BSA1
1/2"-3/4" CLAMP 60°	621-00267	BSA1-6L-60-TC.5XTC.375	.5" CLAMP SAMPLE VALVE 60 DEG 3/8" TC 316L SF4 3A	
1"-1 1/2" CLAMP 60°	621-00268	BSA1-6L-60-TC1.0XTC.375	1.0" CLAMP SAMPLE VALVE 60 DEG 3/8" TC 316L SF4 3A	
1/2"-3/4" CLAMP 90°	621-00269	BSA1-6L-90-TC.5XTC.375	.5" CLAMP SAMPLE VALVE 90 DEG 3/8" TC 316L SF4 3A	
1"-1 1/2" CLAMP 90°	621-00270	BSA1-6L-90-TC1.0XTC.375	1.0" CLAMP SAMPLE VALVE 90 DEG 3/8" TC 316L SF4 3A	
1" WELD 60°	621-00271	BSA1-6L-60-W1.0XTC.375	1.0" WELD SAMPLE VALVE 60 DEG 3/8" TC 316L SF4 3A	
1" WELD 90°	621-00272	BSA1-6L-90-W1.0XTC.375	1.0" WELD SAMPLE VALVE 90 DEG 3/8" TC 316L SF4 3A	



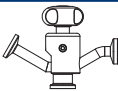
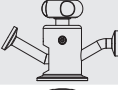
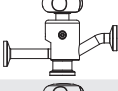
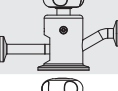
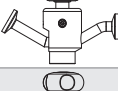
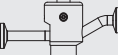

MaxPure A2 3A CCC Series

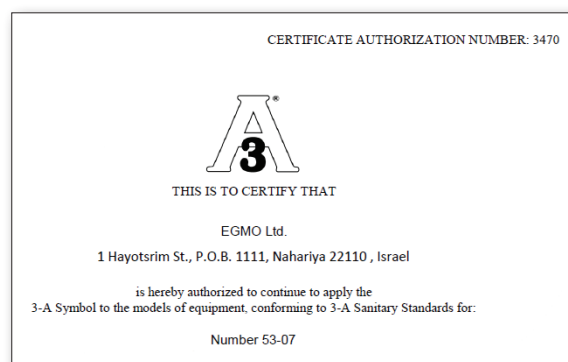
Type	Item Number	Name	Description	BSA2
1/2"-3/4" CLAMP 60°	621-00261	BSA2-6L-60-TC.5XTC.375	.5" CLAMP SAMPLE VALVE 60 DEG 3/8" TC & TC 316L SF4 3A	
1"-1 1/2" CLAMP 60°	621-00262	BSA2-6L-60-TC1.0XTC.375	1.0" CLAMP SAMPLE VALVE 60 DEG 3/8" TC & TC 316L SF4 3A	
1/2"-3/4" CLAMP 90°	621-00263	BSA2-6L-90-TC.5XTC.375	.5" CLAMP SAMPLE VALVE 90 DEG 3/8" TC & TC 316L SF4 3A	
1"-1 1/2" CLAMP 90°	621-00264	BSA2-6L-90-TC1.0XTC.375	1.0" CLAMP SAMPLE VALVE 90 DEG 3/8" TC & TC 316L SF4 3A	
1" WELD 60°	621-00265	BSA2-6L-60-W1.0XTC.375	1.0" WELD SAMPLE VALVE 60 DEG 3/8" TC & TC 316L SF4 3A	
1" WELD 90°	621-00266	BSA2-6L-90-W1.0XTC.375	1.0" WELD SAMPLE VALVE 90 DEG 3/8" TC & TC 316L SF4 3A	

Conforming to 3-A Sanitary Standards for No. 53-07.
 CERTIFICATE AUTHORIZATION NUMBER: 3470



Spare Parts

Part No.	Name	Description	Material	Qty.	Illustration
621-00253	Kit*	Spare Parts Kit		1	
621-00303	Stem	Rigid Stem	SS 316/PTFE	1	
624-00525	O-Ring 10X2.5 Viton	O-RING 10X2.5 VITON 75 FDA	Viton FDA	1	
624-00433	O-Ring 2-018 Viton	O-RING 2-018 VITON	Viton	1	
621-00043	RETAINING RING	RETAINING RING SS304	SS 304	1	

* The Kit includes the 4 items below.

Upon Request

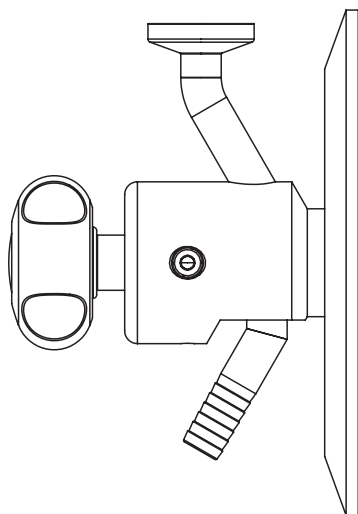

Up to 6" connection

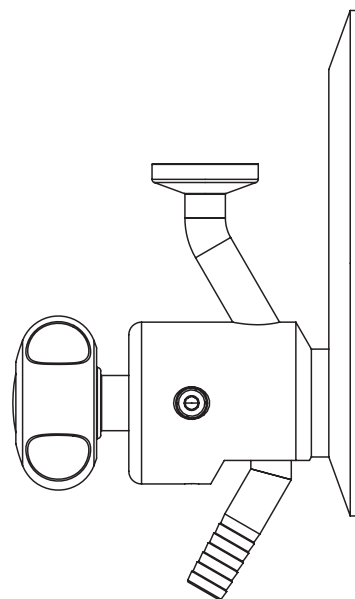

Eccentric

NEUMO EHRENBERG GROUP

GLOBAL LOCATIONS



VNE Corporation
North, South and Latin America
Tel: +1 800 356 1111
+1 608 756 4930
Fax: +1 608 756 3643
E-Mail: stainless@vncorp.com
www.vnestainless.com
U.S.A



EGMO Ltd.
Tel: +972 (0) 4 9855 176
+972 (0) 4 9855 111
Fax: +972 (0) 4 9855 175
E-Mail: salese@egmo.co.il
www.egmo.co.il
ISRAEL



Herrli AG
Tel: +41 (0) 31 750 12 11
Fax: +41 (0) 31 750 12 00
E-Mail: info@herrli.net
www.herrli.net
SWITZERLAND



HPT Inc.
Tel: +845.452.1103
+800.284.4478
E-Mail: sales@hptinc.com
http://www.hptinc.com/
U.S.A



NEUMO Polska Sp. z.o.o
Tel: +48 (0) 46 833 4306
Fax: +48 (0) 46 832 5626
E-Mail: neumo@neumo.pl
POLAND



NEUMO Budapest Kft
Tel: +36 (1) 3174177
+36 (1) 3185982
Fax: +36 (1) 266 8765
E-Mail: neumo@neumo.hu
www.neumo.hu
HUNGARY



NEUMO-EGMO Spain S.L
Tel: +34 977 524 914
Fax: +34 977 524 898
E-Mail: neumo-es@neumo-es.com
www.neumo-es.com
SPAIN



NEUMO Turkey
Tel: +90 (212) 875 01 41
Fax: +90 (212) 875 23 13
E-Mail: info@neumo.com.tr
www.neumo.com.tr
TURKEY



NEUMO UK Ltd.
Tel: +44 (0) 1952 583 999
Fax: +44 (0) 1952 583 958
E-Mail: stainless@neumo.co.uk
www.neumo.co.uk
UNITED KINGDOM



NEUMO GmbH+Co. KG (D)
Tel: +49 (0) 7043 36 0
Fax: +49 (0) 7043 36 179
E-Mail: info@neumo.de
www.neumo.de
GERMANY



NEUMO - VARGUS (Shanghai)
Trading Co., Ltd
Tel: +86 (21) 51688300
Fax: +86 (21) 51688380
E - Mail: info@neumo.com.cn
CHINA



Damstahl a/s (Denmark)
Tel: +45 (0) 8794 4000
Fax: +45 (0) 8794 4150
E-Mail: ds@damstahl.com
www.damstahl.dk
DENMARK



AWH Armaturenwerke (D)
Hötensleben GmbH
Tel: +49 (0) 39405 92 0
Fax: +49 (0) 39405 92 111
E-Mail: info@awh.de
www.awh.de



NEUMO
Tel: +353 (0)21 4975540
Cel: +353 (0)87 2330469
E-Mail: dosullivan@neumo.de
www.neumo.de/en/
IRELAND



Damstahl a/b (Sweden)
Tel: +46 87 61 71 00
Fax: +46 87 61 14 05
www.damstahl.se
SWEDEN

Damstahl GmbH (D)
Tel: +49 (0) 2173 797 0
Fax: +49 (0) 2173 797 274
E-Mail: ds@damstahl.de
www.damstahl.de



Damstahl a/s Oslo (N)
Tel: +47 5615 1570
Fax: +47 5615 1571
E-Mail: dano@damstahl.com
www.damstahl.no
NORWAY



NEUMO LLC
Tel: +84 908475382
E-Mail: Minh.Vietnam@neumo.de
www.awh.eu
VIETNAM

Gebr. Rieger GmbH+Co. KG (D)
Tel: +49 (0) 7361 5702 0
Fax: +49 (0) 7361 5702 51
E-Mail: info@rr-rieger.de
www.rr-rieger.de
GERMANY