

A member of NEUMO Ehrenberg Group



**VNE**

# **Fittings Price Book**

Stainless Solutions For Life





## CLAMP FITTINGS....

Clamp Style Fittings are most popular for easy assembly and breakdown of process lines and equipment. VNE offers Clamp Fittings in T304 and T316L materials in 1/2" through 12" sizes.

Gaskets for Clamp Fittings are available in several different materials, Buna-N, EPDM, Teflon®, and Viton®. Lightweight and heavy-duty clamps complete the unions. VNE's Clamp Fittings meet all 3A requirements.

## CLAMP FITTING SPECIFICATIONS....

**Size Range:** 1/2" OD through 12" OD

**Materials:** T304  
T316L

**Finish:** No. 7 - ID & OD  
No. 5 - OD only  
No. 3 - ID only  
No. 1 - unpolished

## ORDERING SPECIFICATIONS....

**Specify:**

- Quantity
- Product description or Part No.
- Size
- Material Type
- Polish Requirements

## LIMITED WARRANTY....

VNE Corporation products are warranted to be free from defects in material and workmanship for a period of one year from the date of shipment. Any product that proves to be defective shall be repaired or replaced at the option of VNE, providing it has been used as recommended and in strict accordance with recognized piping practices, and that has not been subject to extraordinary service, such as encountered under severe corrosive or abrasive conditions.

VNE makes no warranties, express or implied, other than those listed above.

VNE shall not be liable for any consequential, indirect, incidental or contingent damages.

# Industry Cross - Reference

## STAINLESS STEEL FITTINGS PRODUCT CATALOG

### CLAMP TYPE

VNE	ALFA LAVAL	WAUKESHA / SPX	BRADFORD	STEEL & O'BRIEN
EG2C	2CMP	2CMP	B2CMP	2CMP
EG2C31CC	2CMP-31MP	2CMP-31MP	B2CM31MP	2CMP-31MP
EG2FPR	2FMP-14	2FMP-14	B2FMP-14	2FMP-14
EG2WU	----	2UMP	B2WVMP	2UMP
EG2FTR	2FMP-15	2FMP-15	B2FMP-15	2FMP-15
EG2K	2KMP	2KMP	B2KMP	2KMP
EG7	7MP	7MP	B7MP	7MP
EG7R	7RMP	7RMP	B7MP	7RMP
EG9	9MP	9MP	B9MP	9MP
EG13	13MHLA	----	13MHLA	----
13MHHM	13MHHM	13MHHM	13MHHM-SN	13MHHM
13MHP	13MHP	13MHP	13MHP	13MHP
EG14HT	14MPHT	14MPHT	14MPHT	14MPHT
EG14W	14MPW	14MPW	14MPW	14MPW
EG14WL	14WLMP	14WLMP	14WLMP	14WLMP
EG14AM7	L14AM7	L14AM7	14AM7	L14AM7
EG2CS	14WMP	14WMP	14WMP	14WMP
EG14RT	14MPHR	14MPHR	14MPHR	14MPHR
EG16A	16AMP	16AMP	16AMP	16AMP
EG17PR	17MP-14	17MP-14	17MP-14	17MP-14
EG17TR	17MP-15	17MP-15	17MP-15	17MP-15
EG21	21MP	21MP	21MP	21MP
EG22	22MP	22MP	22MP	22MP
EG31R	31RMP	31RMP	----	31RMP
EG31CC	31-14MP	31-14MP	B3114MP	31-14MP
EG32CC	32-14MP	32-14MP	B3214MP	32-14MP
EG31PC	31PMP	31PMP	B14C31	31PMP
EG32PC	32PMP	32PMP	B14C32	32PMP
EG31CP	31MPP	31MPP	B31-14	31MPP
EG32CP	32MPP	32MPP	B32-15	32MPP
EG31TC	31TMP	31TMP	B15-C31	31TMP
EG32TC	32TMP	32TMP	B15-C32	32TMP
EG31CT	31MPT	31MPT	BC31-15	31MPT
EG32CT	32MPT	32MPT	BC32-15	32MPT
EG40	40MPU	40MPU	40MP-U	40MPU
EG40T	40MPG	40MPG	40MP-G	40MPG
EG23B	23BMP	23BMP	B28BMP	23BMP
EG28A	28AMP	28AMP	B28AMP	28AMP
EG28B	28BMP	28BMP	B31WMP	28BMP

# CLAMP FITTINGS

## STAINLESS STEEL FITTINGS PRICE BOOK

### EG2C - 90° ELBOW

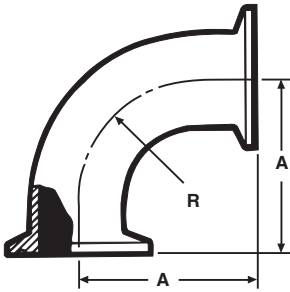

Size Tube OD	T304	T316L
1	\$28.30	\$38.67
1 1/2	\$28.56	\$39.67
2	\$38.33	\$52.00
2 1/2	\$52.30	\$74.00
3	\$60.50	\$102.34
4	\$123.00	\$155.56
6	\$420.81	\$482.47
8	\$1,391.12	\$1,546.92

### EG2WU - CLAMP 180° U-BEND

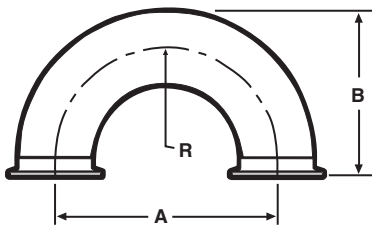

Size Tube OD	T304	T316L
1/2	T316L	\$577.78
3/4	T316L	\$577.78
1	\$233.34	\$205.56
1 1/4	POA	POA
1 1/2	\$233.33	\$328.89
2	\$286.67	\$337.78
2 1/2	\$326.67	\$355.56
3	\$371.11	\$511.11
4	\$546.67	\$688.89
6	\$1,500.00	\$1,677.78

### EG2FPR - 90° ELBOW

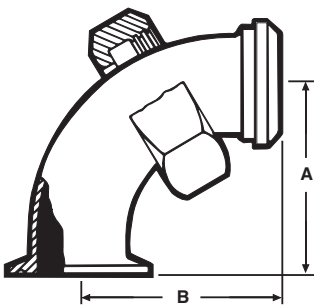

Size Tube OD	T304	T316L
1	\$90.22	\$117.78
1 1/2	\$90.22	\$136.67
2	\$120.00	\$194.44
2 1/2	\$170.22	\$271.11
3	\$222.22	\$355.56
4	\$366.67	\$423.33

### EG2FTR - 90° ELBOW

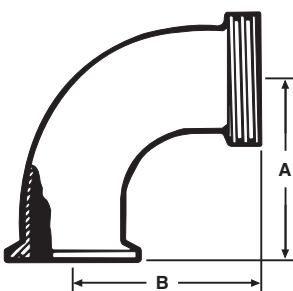

Size Tube OD	T304	T316L
1	\$82.22	\$109.67
1 1/2	\$71.22	\$95.00
2	\$95.22	\$141.78
2 1/2	\$131.11	\$174.89
3	\$148.78	\$198.44
4	\$223.78	\$344.44

# CLAMP FITTINGS

## STAINLESS STEEL FITTINGS PRICE BOOK

### EG2C-31CC - 90° REDUCING ELBOW (Non-Tapered)

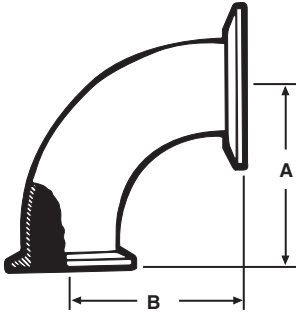

Size Tube OD	T304	T316L
2 X 1	\$124.51	\$193.33
2 X 1 1/2	\$120.89	\$155.22
2 1/2 X 1 1/2	\$133.22	\$209.98
2 1/2 X 2	\$146.10	\$277.38
3 X 1 1/2	\$177.78	\$284.44
3 X 2	\$170.67	\$222.22
3 X 2 1/2	\$170.67	\$311.11
4 X 2 1/2	\$368.89	\$373.33
4 X 3	\$385.56	\$652.22
6 X 4	\$444.44	\$688.89

### EG231-FPR 90° REDUCING ELBOW (Non-Tapered)

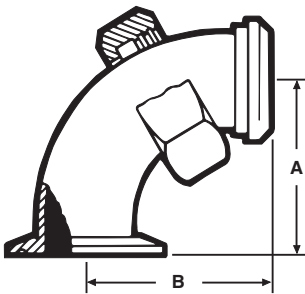

Size Tube OD	T304	T316L
2 X 1	\$221.89	\$226.44
2 X 1 1/2	\$216.26	\$222.22
2 1/2 X 1 1/2	\$244.44	\$256.67
2 1/2 X 2	\$248.89	\$266.22
3 X 1 1/2	\$237.78	\$246.67
3 X 2	\$255.71	\$288.89
3 X 2 1/2	\$271.11	\$333.89
4 X 2 1/2	\$307.29	\$374.00
4 X 3	\$322.22	\$442.22

### EG2C-31PR - 90° REDUCING ELBOW (Non-Tapered)

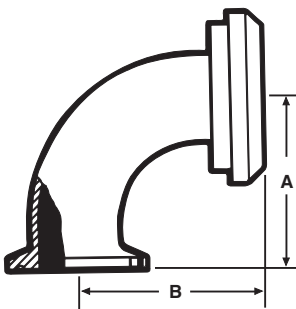

Size Tube OD	T304	T316L
2 X 1	\$221.89	\$226.44
2 X 1 1/2	\$216.26	\$222.22
2 1/2 X 1 1/2	\$244.44	\$256.67
2 1/2 X 2	\$248.89	\$266.22
3 X 1 1/2	\$237.78	\$246.67
3 X 2	\$255.71	\$288.89
3 X 2 1/2	\$271.11	\$333.89
4 X 2 1/2	\$307.29	\$374.00
4 X 3	\$322.22	\$442.22

# CLAMP FITTINGS

## STAINLESS STEEL FITTINGS PRICE BOOK

### EG2K - 45° ELBOW

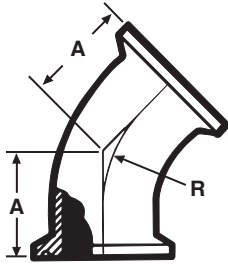

Size Tube OD	T304	T316L
1	\$30.22	\$46.00
1 1/2	\$30.22	\$50.20
2	\$37.11	\$58.67
2 1/2	\$51.12	\$77.78
3	\$67.00	\$113.34
4	\$112.89	\$143.89
6	\$414.90	\$592.60
8	\$888.89	\$1,044.44

### EG7 - TEE

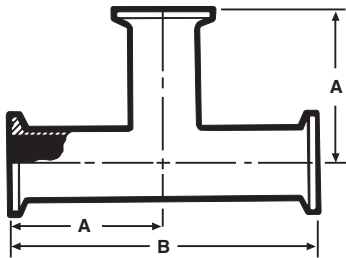

Size Tube OD	T304	T316L
1	\$52.00	\$80.00
1 1/2	\$51.78	\$71.00
2	\$58.89	\$82.00
2 1/2	\$79.11	\$107.11
3	\$112.49	\$153.89
4	\$160.84	\$221.29
6	\$726.32	\$882.47
8	\$1,733.34	\$1,888.89

### EG7R - REDUCING TEE

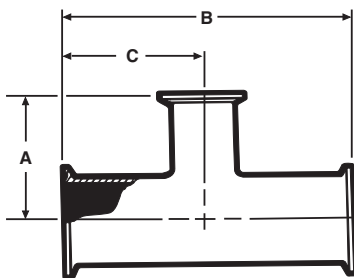

Size Tube OD	T304	T316L
1 1/2 X 1	\$184.22	\$186.67
2 X 1	\$146.67	\$200.00
2 X 1 1/2	\$95.78	\$193.33
2 1/2 X 1 1/2	\$185.78	\$282.22
2 1/2 X 2	\$121.00	\$209.11
3 X 1 1/2	\$308.89	\$408.89
3 X 2	\$147.58	\$216.29
3 X 2 1/2	\$160.09	\$242.22
4 X 2	\$406.67	\$583.33
4 X 2 1/2	\$388.89	\$433.33
4 X 3	\$253.33	\$337.78
6 X 3	\$711.11	\$848.89
6 X 4	\$711.11	\$988.89

# CLAMP FITTINGS

## STAINLESS STEEL FITTINGS PRICE BOOK

### EG9 - CROSS

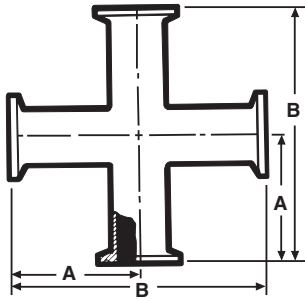

Size Tube OD	T304	T316L
1	\$171.11	\$244.44
1 1/2	\$120.89	\$201.82
2	\$145.04	\$242.80
2 1/2	\$196.56	\$284.84
3	\$245.96	\$395.22
4	\$454.09	\$764.16
6	\$1,555.56	\$1,766.67

### EG14AM7 - WELDING FERRULE

Size Tube OD	T304	T316L
1/2	N/A	\$8.89
3/4	N/A	\$8.89
1	\$6.00	\$8.31
1 1/4	N/A	\$48.89
1 1/2	\$6.00	\$8.31
2	\$7.78	\$9.71
2 1/2	\$10.00	\$16.42
3	\$13.11	\$17.80
4	\$17.73	\$25.47
5	N/A	\$218.44
6	\$108.89	\$110.28
8	N/A	\$384.44
10	N/A	\$566.67
12	N/A	\$811.11

### EG14R - RECESSLESS FERRULE (Expanding)

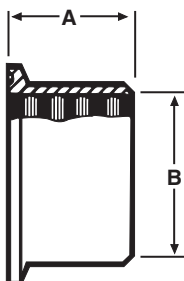

Size Tube OD	T304	T316L
1	\$5.30	\$12.00
1 1/2	\$5.20	\$8.00
2	\$7.44	\$10.44
2 1/2	\$11.50	\$20.00
3	\$14.31	\$30.20
4	\$19.98	\$71.50

# CLAMP FITTINGS

## EG2CS - SHORT WELDING FERRULE

Size Tube OD	T304	T316L
1/4	N/A	\$40.33
3/8	N/A	\$40.33
1/2	N/A	\$8.89
5/8	N/A	\$40.33
3/4	N/A	\$8.89
1	\$4.00	POA
1 1/4	N/A	\$44.44
1 1/2	\$4.00	\$5.00
2	\$4.89	\$6.22
2 1/2	\$7.34	\$11.11
3	\$10.00	\$13.34
4	\$15.73	\$20.89
5	N/A	\$138.00
6	\$67.14	\$78.38
8	\$86.72	\$237.78
10	\$311.11	\$333.33
12	N/A	\$551.11

## EG2CS31 - SHORT REDUCING CLAMP FERRULES



Size Tube OD	T304	T316L
1 X 1/2	N/A	\$37.78
1 X 3/4	N/A	\$37.78
1 1/2 X 1	N/A	\$32.00
2 X 1	N/A	\$40.00
2 X 1 1/2	N/A	\$40.00
2 1/2 X 1 1/2	N/A	\$66.67
2 1/2 X 2	N/A	\$66.67
3 X 1	N/A	\$77.78
3 X 1 1/2	N/A	\$77.78
3 X 2	N/A	\$77.78
3 X 2 1/2	N/A	\$77.78
4 X 1 1/2	N/A	\$115.00
4 X 2	N/A	\$115.00
4 X 2 1/2	N/A	\$115.00
4 X 3	N/A	\$115.00
6 X 4	N/A	\$266.67



# CLAMP FITTINGS

## EG14W - TANK WELDING FERRULE

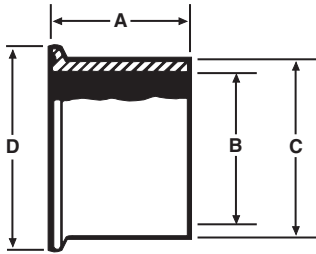

Size Tube OD	T304	T316L
1	\$14.00	\$21.60
1 1/2	\$13.00	\$21.60
2	\$16.00	\$27.30
2 1/2	\$27.80	\$38.11
3	\$31.30	\$50.20
4	\$67.90	\$91.62
6	POA	POA

## EG14W-C6L - ASME CODED TANK FERRULE

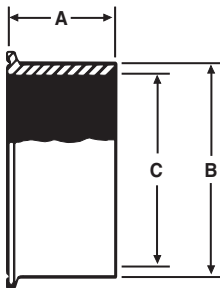

Size Tube OD	T304	T316L
1/2	N/A	\$42.44
1 1/2	N/A	\$42.00
2	N/A	\$60.89
2 1/2	N/A	\$70.44
3	N/A	\$150.62
4	N/A	\$155.56
6	N/A	\$534.60

## EG14WSL-C6L - ASME CODED TANK FERRULE LONG

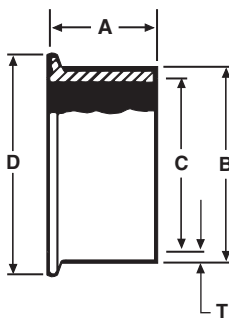

Size Tube OD	T304	T316L
1	N/A	\$123.56
1 1/2	N/A	\$65.56
2	N/A	\$87.11
2 1/2	N/A	\$101.44
3	N/A	\$156.89
4	N/A	\$355.56
6	N/A	\$588.89

# CLAMP FITTINGS

STAINLESS STEEL FITTINGS  
PRICE BOOK

## EG14WL - TANK WELDING FERRULE

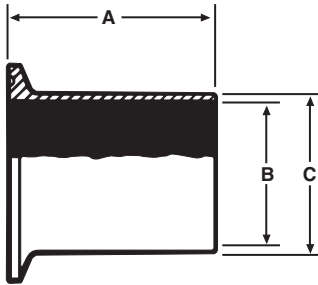

Size Tube OD	T304	T316L
1	\$28.89	\$47.89
1 1/2	\$26.44	\$37.78
2	\$31.89	\$40.00
2 1/2	\$46.00	\$57.80
3	\$61.00	\$76.40
4	\$93.22	\$116.00
6	\$222.22	\$277.78
8	\$466.67	\$511.11
10	\$817.78	\$888.89
12	N/A	\$1,444.44

## EG14RT - RUBBER HOSE ADAPTER



Size Tube OD	T304	T316L
1 / 2	N/A	\$62.33
3/4	N/A	\$64.00
1	\$32.67	\$75.11
1 1/4	N/A	\$100.00
1 1/2	\$32.67	\$63.11
2	\$42.00	\$82.89
2 1/2	\$52.67	\$105.56
3	\$68.22	\$128.89
4	\$173.33	\$206.67
6	\$578.64	\$666.67

## EG14RT - RUBBER HOSE ADAPTER REDUCER

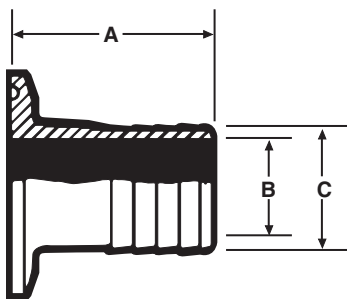

Size Tube OD	T304	T316L
1 X 1/2	N/A	\$73.56
1 X 3/4	N/A	\$97.78
1 1/2 X 1 1/4	N/A	\$126.89
2 X 1	N/A	\$133.11
2 X 1 1/2	N/A	\$133.11
2 1/2 X 2	N/A	\$156.67
3 X 2	N/A	\$166.67
3 X 2 1/2	N/A	\$201.11
4 X 2 1/2	N/A	\$257.78
4 X 3	N/A	\$286.67

# CLAMP FITTINGS

## STAINLESS STEEL FITTINGS PRICE BOOK

### EG14HT - TYGON HOSE ADAPTER

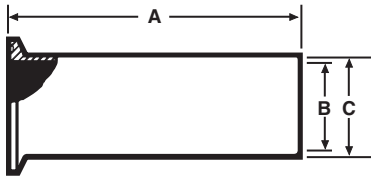

Size Tube OD	T304	T316L
1	\$28.89	\$40.40
1 1/2	\$26.67	\$34.60
2	\$32.78	\$49.11
2 1/2	\$44.11	\$58.67
3	\$51.56	\$72.23
4	\$83.33	\$115.56

### EG17PR - ADAPTER

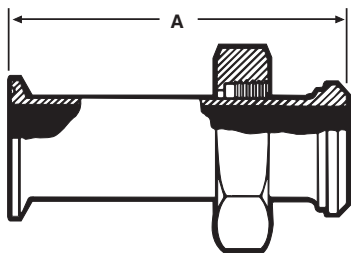

Size Tube OD	T304	T316L
1	\$84.80	\$152.00
1 1/2	\$78.70	\$116.00
2	\$101.00	\$148.00
2 1/2	\$130.00	\$213.00
3	\$179.00	\$293.00
4	\$274.00	\$413.00

### EG17TR - ADAPTER



Size Tube OD	T304	T316L
1	\$49.30	\$74.50
1 1/2	\$48.20	\$72.00
2	\$59.90	\$94.70
2 1/2	\$84.00	\$133.00
3	\$99.80	\$159.00
4	\$156.62	\$335.00

### EG21 - MALE ADAPTER (N.P.T. Pipe Threads)

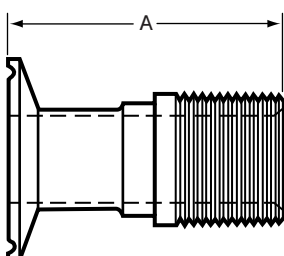

Size Tube OD	T304	T316L
1	\$53.64	\$65.75
1 1/4	T316L	\$197.78
1 1/2	\$55.25	\$68.38
2	\$64.09	\$94.62
2 1/2	\$101.44	\$132.05
3	\$127.47	\$172.78
4	\$173.85	\$258.11
6	POA	POA

# CLAMP FITTINGS

## STAINLESS STEEL FITTINGS PRICE BOOK

### EG21-6L - MALE ADAPTER REDUCING

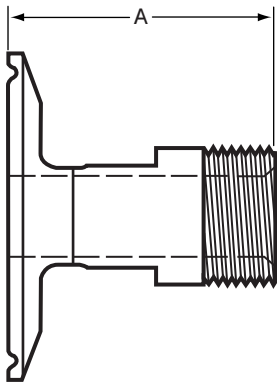

Size Tube OD	T304	T316L
3/4 X 1/2	N/A	\$111.11
1 X 1/2	N/A	\$97.38
1 X 3/4	N/A	\$101.02
1 1/2 X 1/2	N/A	\$97.38
1 1/2 X 3/4	N/A	\$101.02
1 1/2 X 1 1/4	N/A	\$96.96
2 X 1	N/A	\$100.67
2 X 1 1/4	N/A	\$159.11
2 X 1 1/2	N/A	\$90.00
2 1/2 X 1 1/2	N/A	\$133.33
2 1/2 X 2	N/A	\$181.00
3 X 1 1/2	N/A	\$166.67
3 X 2	N/A	\$193.34
3 X 2 1/2	N/A	\$197.78
4 X 2	N/A	\$306.67
4 X 2 1/2	N/A	\$255.56
4 X 3	N/A	\$244.44
6 X 4	N/A	\$511.11

### EG22 - FEMALE ADAPTER (N.P.T. Pipe Threads)

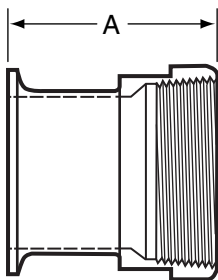

Size Tube OD	T304	T316L
1	\$53.53	\$65.75
1 1/4	POA	POA
1 1/2	\$55.58	\$68.38
2	\$64.80	\$94.62
2 1/2	\$100.62	\$132.05
3	\$127.93	\$172.78
4	\$173.42	\$258.11

# CLAMP FITTINGS

## STAINLESS STEEL FITTINGS PRICE BOOK

### EG22 - FEMALE ADAPTER REDUCING

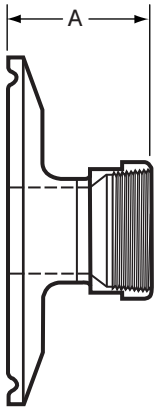

Size Tube OD	T304	T316L
3/4 X 1/2	N/A	\$81.13
1 X 1/2	N/A	\$109.54
1 X 3/4	N/A	\$113.20
1 1/2 X 1/2	N/A	\$109.54
1 1/2 X 3/4	N/A	\$113.20
1 1/2 X 1 1/4	N/A	\$161.89
2 X 1	N/A	\$162.29
2 X 1 1/4	N/A	\$197.78
2 X 1 1/2	N/A	\$149.00
2 1/2 X 1 1/2	N/A	\$174.44
2 1/2 X 2	N/A	\$187.78
3 X 1 1/2	N/A	\$227.78
3 X 2	N/A	\$227.78
3 X 2 1/2	N/A	\$238.89
4 X 2	N/A	\$402.22
4 X 2 1/2	N/A	\$413.33
4 X 3	N/A	\$422.22

### EG16A - SOLID END CAP

Size Tube OD	T304	T316L
1/2 & 3/4	N/A	\$6.22
1 & 1 1/2	\$4.00	\$5.00
2	\$5.11	\$6.90
2 1/2	\$8.00	\$11.12
3	\$10.72	\$14.70
4	\$20.56	\$27.04
5	N/A	\$138.89
6	\$80.11	\$98.60
8	N/A	\$222.22
10	N/A	\$611.11
12	N/A	\$824.44

# CLAMP FITTINGS

## STAINLESS STEEL FITTINGS PRICE BOOK

### EG23B-6L - CLAMP THERMOMETER CAPS

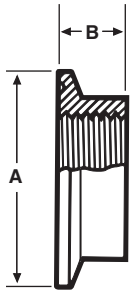

Size Tube OD	T304	T316L
1	N/A	\$58.67
1 1/2	N/A	\$58.67
2	N/A	\$77.78
2 1/2	N/A	\$85.22
3	N/A	\$108.11
4	N/A	\$168.89

### GASKETS



Size Tube OD	EG40 (Buna)	EG40F (Buna)	EG40E (EPDM)	EG40FE (EPDM)	EG40V (Viton)	EG40FV (Viton)
1/2	\$1.78	N/A	\$2.11	N/A	\$4.89	N/A
3/4	\$2.11	N/A	\$2.11	N/A	\$5.56	N/A
1	\$0.67	\$1.33	\$1.67	\$2.22	\$5.78	\$8.33
1 1/2	\$0.44	\$1.44	\$1.67	\$2.44	\$4.11	\$6.00
2	\$0.44	\$1.33	\$1.78	\$2.56	\$4.78	\$7.11
2 1/2	\$0.67	\$1.56	\$2.00	\$3.56	\$7.11	\$11.89
3	\$0.89	\$2.22	\$2.22	\$4.00	\$10.22	\$12.44
4	\$1.44	\$2.89	\$2.44	\$4.11	\$12.78	\$13.30
5	\$5.56	POA	\$16.11	POA	\$40.22	POA
6	\$7.78	\$19.89	\$19.78	\$24.22	\$36.67	\$42.22
8	N/A	\$21.89	N/A	\$42.67	N/A	\$71.78
10	N/A	\$32.78	N/A	\$48.89	N/A	\$77.78
12	N/A	\$34.44	N/A	\$53.33	N/A	\$81.67

### GASKETS



Size Tube OD	EG40S (Silicone)	EG40FS (Silicone)	EG40T (Teflon)	EG40TS (Tef-Steel)	EG40GR (EPDM)	EG40GRV (Viton)
1/2	\$2.44	\$2.33	\$3.22	\$6.00	\$11.44	\$11.44
3/4	\$2.44	\$2.67	\$3.33	\$6.11	\$11.56	\$11.56
1	\$2.56	\$3.11	\$1.89	\$15.89	\$4.33	\$4.33
1 1/2	\$2.22	\$3.11	\$1.56	\$11.56	\$3.89	\$3.89
2	\$2.44	\$3.33	\$1.67	\$16.44	\$5.11	\$5.11
2 1/2	\$3.33	\$4.22	\$1.89	\$17.78	\$6.00	\$6.00
3	\$3.56	\$5.00	\$2.22	\$23.22	\$6.67	\$6.67
4	\$4.11	\$5.89	\$3.11	\$29.44	\$12.33	\$12.33
5	\$20.56	POA	POA	POA	POA	POA
6	\$18.67	\$20.00	\$28.89	\$74.44	\$34.22	\$34.22
8	N/A	\$32.89	\$60.00	\$100.00	\$93.33	\$93.33
10	N/A	\$34.22	\$77.00	POA	\$135.00	\$135.00
12	N/A	\$41.11	\$180.00	POA	POA	POA

# CLAMP FITTINGS

## STAINLESS STEEL FITTINGS PRICE BOOK

### 13MHM - HEAVY DUTY CLAMP

Size Tube OD	T304	T316L
1/2 & 3/4	\$6.11	N/A
1 & 1 1/2	\$7.78	N/A
2	\$9.56	N/A
2 1/2	\$10.89	N/A
3	\$12.23	N/A
4	\$14.67	N/A
5	\$44.44	N/A
6	\$36.51	N/A
8	\$53.58	N/A
10	\$143.00	N/A
12	\$333.33	N/A

### 13MHMD - DOUBLE HINGED HEAVY DUTY CLAMP

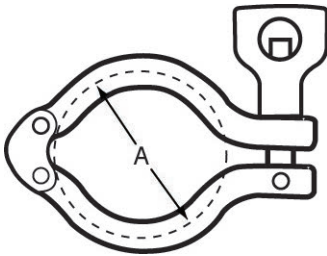

Size Tube OD	T304	T316L
1 & 1 1/2	\$10.78	N/A
2	\$12.18	N/A
2 1/2	\$15.20	N/A
3	\$16.23	N/A
4	\$19.29	N/A

### 13MHM-H - HEAVY DUTY CLAMP (Wing nut With Hole)

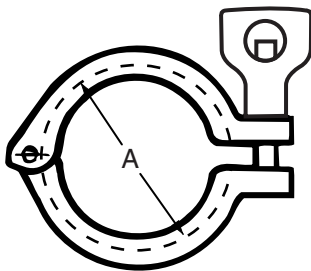

Size Tube OD	T304	T316L
1/2 & 3/4	\$6.11	N/A
1 & 1 1/2	\$7.78	N/A
2	\$9.56	N/A
2 1/2	\$10.89	N/A
3	\$12.23	N/A
4	\$14.67	N/A
5	\$44.44	N/A
6	\$36.51	N/A
8	\$53.58	N/A
10	\$143.00	N/A
12	\$333.33	N/A

### 13MHHS - THREE PIECE HEAVY DUTY CLAMP

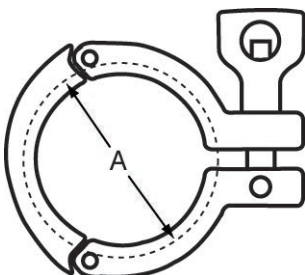

Size Tube OD	T304	T316L
1 1/2	\$14.71	N/A
2	\$16.50	N/A
2 1/2	\$19.80	N/A
3	\$23.12	N/A
4	\$28.13	N/A

# CLAMP FITTINGS

STAINLESS STEEL FITTINGS  
PRICE BOOK

## 13MHP - HIGH PRESSURE CLAMP

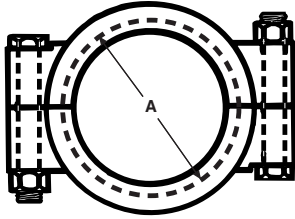

Size Tube OD	T304	T316L
1/2 & 3/4	\$16.20	N/A
1 & 1 1/2	\$15.89	N/A
2	\$20.67	N/A
2 1/2	\$22.67	N/A
3	\$28.67	N/A
4	\$31.12	N/A
6	\$54.44	N/A

## EG13 - HINGED CLAMP - (Light Duty)

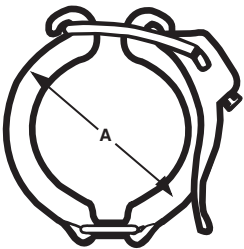

Size Tube OD	T304	T316L
1 & 1 1/2	\$21.53	N/A
2	\$22.67	N/A
2 1/2	\$25.02	N/A
3	\$33.13	N/A
4	\$35.33	N/A



# CLAMP FITTINGS

STAINLESS STEEL FITTINGS  
PRICE BOOK

## EG28A - 45° CLAMP LATERAL

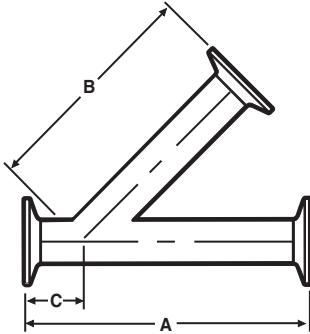

Size Tube OD	T304	T316L
1	\$322.22	\$376.58
1 1/2	\$322.22	\$366.49
2	\$337.78	\$378.42
2 1/2	\$395.56	\$518.02
3	\$431.11	\$587.82
4	\$711.11	\$1028.71
6	\$1,684.44	\$2,034.45

## EG28B - CLAMP TRUE Y

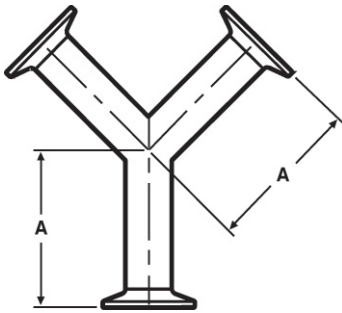

Size Tube OD	304	316L
1	\$322.22	\$376.58
1 1/2	\$322.22	\$366.49
2	\$337.78	\$378.42
2 1/2	\$395.56	\$518.02
3	\$431.11	\$587.82
4	\$711.11	\$1028.71
6	\$1,684.44	\$2,034.44

# CLAMP FITTINGS

STAINLESS STEEL FITTINGS  
PRICE BOOK

## EG28RA - 45° CLAMP REDUCING LATERAL

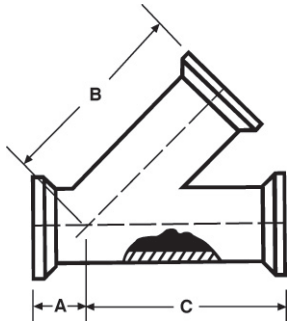

Size Tube OD	T304	T316L
1 1/2 X 1	POA	POA
2 X 1	POA	POA
2 X 1 1/2	POA	POA
2 1/2 X 2	POA	POA
3 X 1	POA	POA
3 X 1 1/2	POA	POA
3 X 2	POA	POA
3 X 2 1/2	POA	POA
4 X 1	POA	POA
4 X 1 1/2	POA	POA
4 X 2	POA	POA
4 X 2 1/2	POA	POA
4 X 3	POA	POA

## EG31CC - CONCENTRIC REDUCER

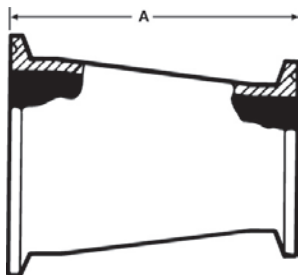

Size Tube OD	T304	T316L
3/4 X 1/2	N/A	\$118.00
1 X 1/2	N/A	\$105.56
1 X 3/4	N/A	\$131.11
1 1/2 X 1/2	N/A	\$151.11
1 1/2 X 3/4	N/A	\$151.11
1 1/2 X 1	\$46.67	\$51.12
1 1/2 X 1 1/4	POA	POA
2 X 1	\$63.69	\$86.67
2 X 1 1/4	POA	POA
2 X 1 1/2	\$49.80	\$54.36
2 1/2 X 1	\$198.00	\$253.33
2 1/2 X 1 1/2	\$67.96	\$73.34
2 1/2 X 2	\$60.60	\$67.34
3 X 1 1/2	\$115.91	\$140.00
3 X 2	\$80.78	\$92.67
3 X 2 1/2	\$74.29	\$80.58
4 X 2	\$153.71	\$180.75
4 X 2 1/2	\$176.33	\$180.15
4 X 3	\$98.87	\$104.44
6 X 3	\$386.22	\$474.00
6 X 4	\$374.92	\$449.49

# CLAMP FITTINGS

## STAINLESS STEEL FITTINGS PRICE BOOK

### EG32CC - ECCENTRIC REDUCER

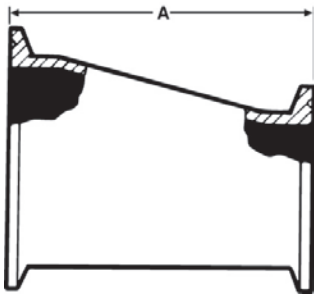

Size Tube OD	T304	T316L
3/4 X 1/2	N/A	\$147.11
1 X 1/2	N/A	\$172.00
1 X 3/4	N/A	\$147.11
1 1/2 X 1/2	N/A	\$276.47
1 1/2 X 3/4	N/A	\$276.47
1 1/2 X 1	\$52.20	\$63.60
1 1/2 X 1 1/4	POA	POA
2 X 1	\$123.11	\$206.22
2 X 1 1/4	POA	POA
2 X 1 1/2	\$59.40	\$71.40
2 1/2 X 1	\$179.11	\$327.78
2 1/2 X 1 1/2	\$81.96	\$99.34
2 1/2 X 2	\$69.00	\$84.22
3 X 1 1/2	\$133.18	\$162.85
3 X 2	\$91.78	\$104.71
3 X 2 1/2	\$119.00	\$123.58
4 X 2	\$202.22	\$200.60
4 X 2 1/2	\$193.78	\$253.67
4 X 3	\$136.64	\$173.11
6 X 3	\$644.44	\$652.00
6 X 4	\$673.33	\$711.12

### EG31PC - ADAPTER REDUCER (Concentric)

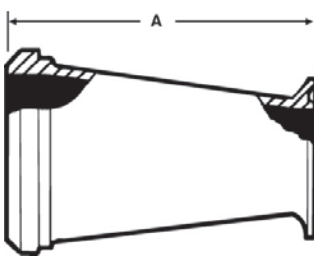

Size Tube OD	T304	T316L
1 1/2 X 1	\$157.78	\$165.56
2 X 1	\$157.78	\$237.78
2 X 1 1/2	\$175.22	\$237.78
2 1/2 X 1 1/2	\$180.56	\$260.00
2 1/2 X 2	\$180.56	\$260.00
3 X 2	\$197.78	\$288.89
3 X 2 1/2	\$197.78	\$288.89
4 X 2 1/2	\$293.33	\$444.44
4 X 3	\$293.33	\$416.67

# CLAMP FITTINGS

## EG32PC - ADAPTER REDUCER (Eccentric)

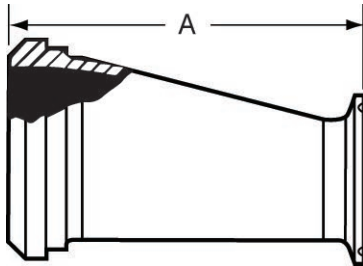

Size Tube OD	T304	T316L
1 1/2 X 1	\$157.78	\$165.56
2 X 1	\$157.78	\$237.78
2 X 1 1/2	\$175.22	\$237.78
2 1/2 X 1 1/2	\$180.56	\$260.00
2 1/2 X 2	\$180.56	\$260.00
3 X 2	\$197.78	\$288.89
3 X 2 1/2	\$197.78	\$288.89
4 X 2 1/2	\$293.33	\$444.44
4 X 3	\$293.33	\$416.67

## EG31CP - ADAPTER REDUCER (Concentric)

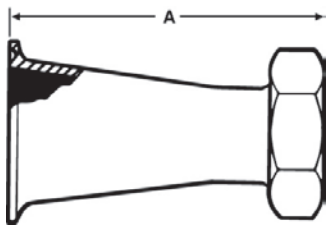

Size Tube OD	T304	T316L
1 1/2 X 1	\$157.78	\$165.56
2 X 1	\$157.78	\$237.78
2 X 1 1/2	\$175.22	\$237.78
2 1/2 X 1 1/2	\$180.56	\$260.00
2 1/2 X 2	\$180.56	\$260.00
3 X 2	\$197.78	\$288.89
3 X 2 1/2	\$197.78	\$288.89
4 X 2 1/2	\$293.33	\$444.44
4 X 3	\$293.33	\$416.67

## EG32CP - ADAPTER REDUCER (Eccentric)

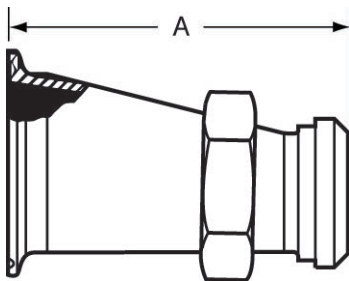

Size Tube OD	T304	T316L
1 1/2 X 1	\$157.78	\$165.56
2 X 1	\$157.78	\$237.78
2 X 1 1/2	\$175.22	\$237.78
2 1/2 X 1 1/2	\$180.56	\$260.00
2 1/2 X 2	\$180.56	\$260.00
3 X 2	\$197.78	\$288.89
3 X 2 1/2	\$197.78	\$288.89
4 X 2 1/2	\$293.33	\$444.44
4 X 3	\$293.33	\$416.67

# CLAMP FITTINGS

## EG31TC - ADAPTER REDUCER (Concentric)

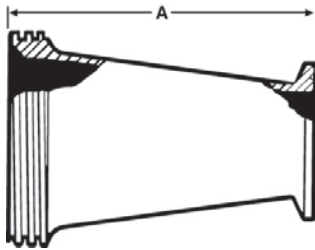

Size Tube OD	T304	T316L
1 1/2 X 1	\$112.22	\$182.22
2 X 1	\$120.00	\$243.33
2 X 1 1/2	\$120.00	\$200.00
2 1/2 X 1 1/2	\$154.44	\$244.44
2 1/2 X 2	\$174.44	\$244.44
3 X 2	\$191.89	\$277.78
3 X 2 1/2	\$191.89	\$283.33
4 X 2 1/2	\$294.44	\$444.44
4 X 3	\$298.89	\$427.78

## EG32TC - ADAPTER REDUCER (Eccentric)

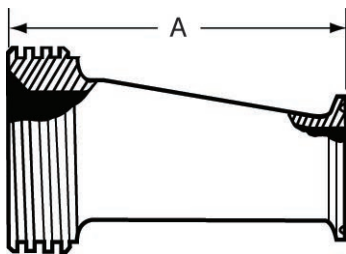

Size Tube OD	T304	T316L
1 1/2 X 1	\$112.22	\$182.22
2 X 1	\$120.00	\$243.33
2 X 1 1/2	\$120.00	\$200.00
2 1/2 X 1 1/2	\$154.44	\$244.44
2 1/2 X 2	\$174.44	\$244.44
3 X 2	\$191.89	\$277.78
3 X 2 1/2	\$191.89	\$283.33
4 X 2 1/2	\$294.44	\$444.44
4 X 3	\$298.89	\$427.78

## EG31CT - ADAPTER REDUCER (Concentric)

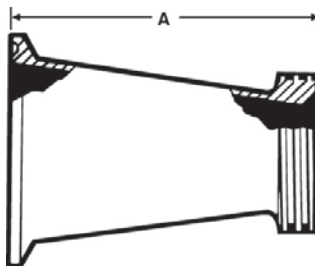

Size Tube OD	T304	T316L
1 1/2 X 1	\$112.22	\$182.22
2 X 1	\$120.00	\$243.33
2 X 1 1/2	\$120.00	\$200.00
2 1/2 X 1 1/2	\$154.44	\$244.44
2 1/2 X 2	\$174.44	\$244.44
3 X 2	\$191.89	\$277.78
3 X 2 1/2	\$191.89	\$283.33
4 X 2 1/2	\$294.44	\$444.44
4 X 3	\$298.89	\$427.78

# CLAMP FITTINGS

## EG32CT - ADAPTER REDUCER (Eccentric)

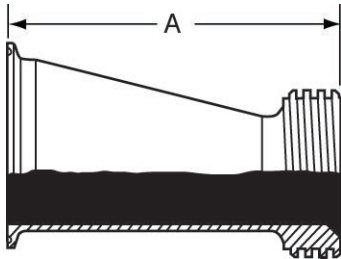

Size Tube OD	T304	T316L
1 1/2 X 1	\$112.22	\$182.22
2 X 1	\$120.00	\$243.33
2 X 1 1/2	\$120.00	\$200.00
2 1/2 X 1 1/2	\$154.44	\$244.44
2 1/2 X 2	\$174.44	\$244.44
3 X 2	\$191.89	\$277.78
3 X 2 1/2	\$191.89	\$283.33
4 X 2 1/2	\$294.44	\$444.44
4 X 3	\$298.89	\$427.78

## CLAMP FITTINGS SCHEDULE 5 & 10

### EG2CS-5-6L - FERRULE

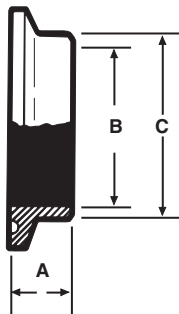

Size Tube OD	T304	T316L
1	N/A	\$30.45
1 1/2	N/A	\$30.45
2	N/A	\$37.78
2 1/2	N/A	\$63.33
3	N/A	\$95.56
4	N/A	\$144.44

### EG2CS-10-6L - FERRULE

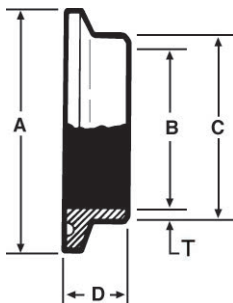

Size Tube OD	T304	T316L
1/2	N/A	POA
3/4	N/A	POA
1	N/A	\$34.89
1 1/2	N/A	\$40.00
2	N/A	\$64.29
2 1/2	N/A	\$91.11
3	N/A	\$101.33
4	N/A	\$124.31

# CLAMP FITTINGS SCHEDULE 5 & 10

STAINLESS STEEL FITTINGS  
PRICE BOOK

## EG14AM7-5-6L - FERRULE

Size Tube OD	T304	T316L
1	N/A	\$43.07
1 1/2	N/A	\$53.33
2	N/A	\$65.64
2 1/2	N/A	\$84.18
3	N/A	\$118.29
4	N/A	\$217.44

## EG14AM7-10-6L - FERRULE

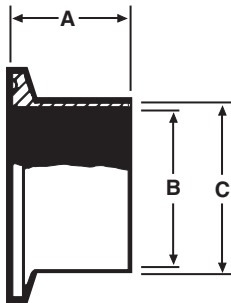

Size Tube OD	T304	T316L
1	N/A	\$39.56
1 1/2	N/A	\$51.11
2	N/A	\$86.22
2 1/2	N/A	\$120.00
3	N/A	\$140.44
4	N/A	\$203.56

## EG16A-5-6L - CAP



Size Tube OD	T304	T316L
1	N/A	\$5.00
1 1/2	N/A	\$6.90
2	N/A	\$10.51
2 1/2	N/A	\$14.70
3	N/A	\$93.33
4	N/A	\$133.33

## 13MHM-5 - CLAMP

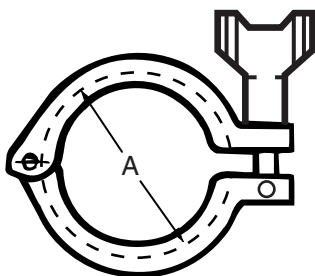

Size Tube OD	T304	T316L
1	\$7.56	N/A
1 1/2	\$8.93	N/A
2	\$10.44	N/A
2 1/2	\$11.76	N/A
3	\$25.64	N/A
4	\$41.33	N/A
6	\$81.94	N/A

# CLAMP FITTINGS SCHEDULE 5 & 10

STAINLESS STEEL FITTINGS  
PRICE BOOK

## GASKETS



SIZE TUBE OD	EG40 - 5 (BUNA)	EG40T - 5 (TEFLON)
1	\$3.67	\$15.44
1 1/2	\$3.67	\$14.56
2	\$3.89	\$15.44
2 1/2	\$4.11	\$17.11
3	\$4.44	\$23.11
4	\$5.22	\$32.56





## WELD FITTINGS....

Weld Fittings are used on permanent installations where process piping and equipment can be cleaned in place (CIP) and removal from the system is not required. Weld Fittings are offered in nominal tube sizes 1/2" through 8" in T304 and T316L materials. Uniform wall thickness for 1/2" through 3" sizes measure .065 (16 ga). In 4" size, wall thickness measures .083 (14 ga), 6" and 8" .109 (12 ga).

VNE offers Polished ID and OD Fittings for immediate shipment. Other polished combinations may be ordered. Our Weld Fittings meet all 3A requirements.

## WELD FITTING SPECIFICATIONS....

**Size Range:** 1/2" OD through 8" OD

**Materials:** T304  
T316L

**Finish:** No. 7 - ID & OD  
No. 5 - OD only  
No. 3 - ID only  
No. 1 - unpolished

## ORDERING SPECIFICATIONS....

**Specify:**

- Quantity
- Product description or Part No.
- Size
- Material Type
- Polish Requirements

## LIMITED WARRANTY....

VNE Corporation products are warranted to be free from defects in material and workmanship for a period of one year from the date of shipment. Any product that proves to be defective shall be repaired or replaced at the option of VNE, providing it has been used as recommended and in strict accordance with recognized piping practices, and that has not been subject to extraordinary service, such as encountered under severe corrosive or abrasive conditions.

VNE makes no warranties, express or implied, other than those listed above.

VNE shall not be liable for any consequential, indirect, incidental or contingent damages.

# INDUSTRY CROSS - REFERENCE

STAINLESS STEEL FITTINGS  
PRODUCT CATALOG

## WELD FITTINGS

VNE	ALFA LAVAL	WAUKESHA / SPX	BRADFORD	STEEL & O'BRIEN
E2S	L2S	2CW	B2S	L2S
E2C	L2CM	2CKW	B2CM	L2CM
E2T	L2C	2TW	B2T	L2C
E2F	L2F	2FW	B2FP	L2F
E2KS	L2KS	2KW	B2KS	L2KS
E2KC	L2KM	2KKW	B2KM	L2KM
E2KT	L2K	2KT	B2K	L2K
E2KP	L2P	2KP	B2P	L2P
E2WU	L2WU	2WU	B2WUL	2WU
E7WWW	L7WWW	7W	B7WWW	7WWW
E7WWC	L7WWM	7WWK	B7WWM	7WWM
E7WWT	L7WWT	7WWT	B7WWT	----
E7WCW	L7WMW	7WKW	B7WMW	7WMW
E7WTW	L7WTW	7WTW	B7WTW	----
E7WCC	L7WMM	7WKK	B7WMM	7WMM
E7WTT	L7WTT	7WTT	B7WTT	----
E7CCW	L7MMW	7KKW	B7MMW	7MMW
E7TTW	L7TTW	7TTW	B7TTW	----
E7RWWW	L7RWWW	7WR	B7RWWW	7WR
E9WWWWW	L9WWWWW	9W	B9WWWWW	9WWWWW
E31WW	L31	31W	B31W	31W
E32WW	L32	32W	B32W	32W
E28WA	L28WA	28WA	B28WA	28WA
E28WB	L28WB	28WB	B28W	28WB
E2WK			B2WK	2WK

# WELD FITTINGS

## STAINLESS STEEL FITTINGS PRICE BOOK

### 2WCL - 90° ELBOW SHORT TANGENT

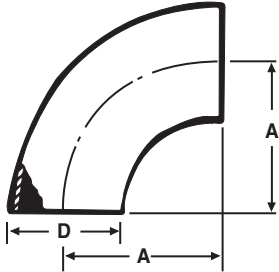

Size Tube OD	T304	T316L
1	\$16.89	\$21.56
1 1/4	\$57.78	\$81.67
1 1/2	\$14.44	\$19.56
2	\$18.44	\$24.11
2 1/2	\$30.00	\$39.78
3	\$34.44	\$51.12
4	\$74.22	\$93.34
6	\$268.75	\$273.21
8	\$822.22	\$944.45

### E2S - 90° ELBOW

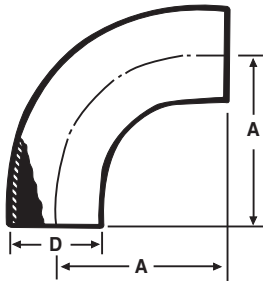

Size Tube OD	T304	T316L
1	\$19.04	\$24.44
1 1/2	\$20.00	\$24.44
2	\$22.00	\$32.58
2 1/2	\$31.74	\$48.89
3	\$43.89	\$73.34
4	\$81.52	\$126.45

### E2C - 90° ELBOW

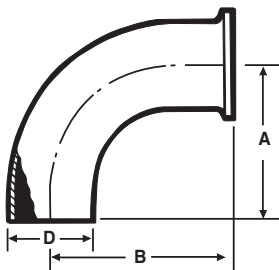

Size Tube OD	T304	T316L
1	\$33.92	\$46.10
1 1/2	\$33.92	\$46.20
2	\$41.16	\$58.60
2 1/2	\$55.27	\$85.49
3	\$70.78	\$116.00
4	\$142.89	\$235.56
6	\$877.78	\$722.22

# WELD FITTINGS

## STAINLESS STEEL FITTINGS PRICE BOOK

### E2F - 90° ELBOW

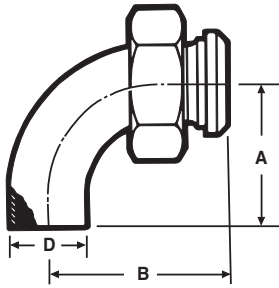

Size Tube OD	T304	T316L
1	\$77.33	\$112.31
1 1/2	\$76.00	\$116.47
2	\$88.22	\$142.11
2 1/2	\$133.33	\$193.53
3	\$150.83	\$263.45
4	\$224.10	\$386.93

### E2T - 90° ELBOW

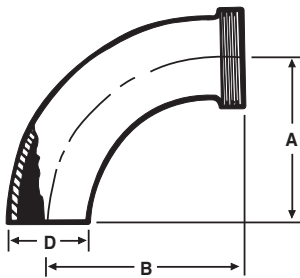

Size Tube OD	T304	T316L
1	\$71.11	\$79.00
1 1/2	\$67.56	\$75.00
2	\$75.67	\$84.11
2 1/2	\$110.00	\$125.56
3	\$128.44	\$180.44
4	\$198.44	\$285.98

### E2WU - 180° U BEND

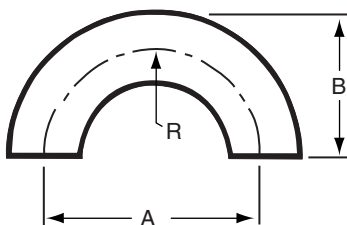

Size Tube OD	T304	T316L
1/2	N/A	POA
3/4	N/A	POA
1	\$166.67	\$185.56
1 1/4	POA	POA
1 1/2	\$211.11	\$234.44
2	\$217.78	\$244.44
2 1/2	\$288.89	\$322.22
3	\$333.33	\$388.89
4	\$388.89	\$455.56
6	\$1,340.00	\$1,666.67

# WELD FITTINGS

## STAINLESS STEEL FITTINGS PRICE BOOK

### E2WK - 45° ELBOW SHORT TANGENT

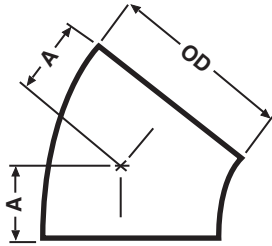

Size Tube OD	T304	T316L
1/2	N/A	\$66.67
3/4	N/A	\$66.67
1	\$22.67	\$35.11
1 1/4	N/A	\$88.89
1 1/2	\$22.67	\$33.78
2	\$25.78	\$39.33
2 1/2	\$37.56	\$46.67
3	\$42.11	\$56.67
4	\$73.33	\$117.33
6	\$231.90	\$268.58
8	\$522.52	\$677.78

### E2KS - 45° ELBOW

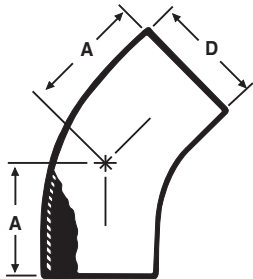

Size Tube OD	T304	T316L
1	\$20.00	\$23.11
1 1/2	\$17.44	\$21.33
2	\$21.47	\$27.05
2 1/2	\$31.18	\$40.74
3	\$42.50	\$57.16
4	\$66.67	\$106.98

### E2KC - 45° ELBOW

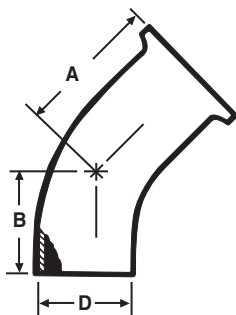

Size Tube OD	T304	T316L
1	\$91.33	\$72.78
1 1/2	\$62.56	\$70.22
2	\$68.00	\$75.56
2 1/2	\$97.00	\$122.22
3	\$114.44	\$146.67
4	\$161.11	\$232.22
6	\$477.78	\$633.33

# WELD FITTINGS

## STAINLESS STEEL FITTINGS PRICE BOOK

### E2KT - 45° ELBOW

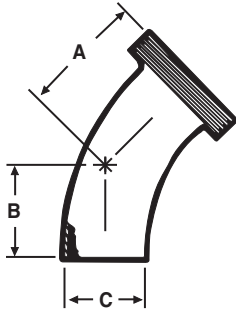

Size Tube OD	T304	T316L
1	\$66.67	\$74.11
1 1/2	\$65.89	\$73.22
2	\$70.44	\$81.67
2 1/2	\$133.33	\$113.20
3	\$117.78	\$164.73
4	\$201.73	\$299.87

### E2KP - 45° ELBOW

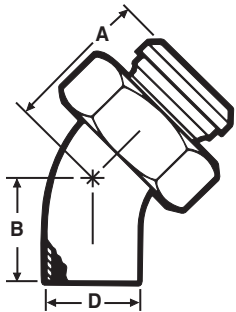

Size Tube OD	T304	T316L
1	\$75.22	\$83.56
1 1/2	\$74.33	\$82.56
2	\$86.11	\$95.67
2 1/2	\$121.11	\$134.44
3	\$188.89	\$181.36
4	\$240.64	\$323.93

### E7WWW - TEE

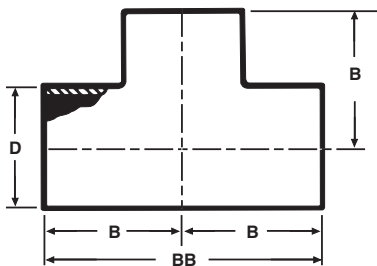

Size Tube OD	T304	T316L
1	\$30.89	\$37.11
1 1/4	POA	POA
1 1/2	\$30.89	\$34.22
2	\$33.00	\$40.44
2 1/2	\$40.67	\$47.94
3	\$56.40	\$70.58
4	\$84.30	\$114.53
6	\$439.08	\$606.06
8	\$1,054.56	\$1,233.33

# WELD FITTINGS

## STAINLESS STEEL FITTINGS PRICE BOOK

### E7RWWW - REDUCING TEE

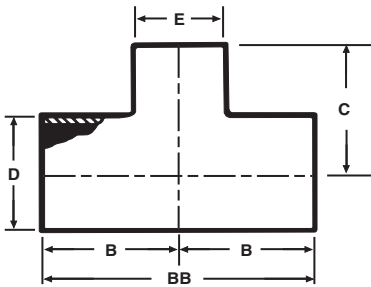

Size Tube OD	T304	T316L
1 1/2 X 1	\$55.56	\$56.89
1 1/2 X 1 1/4	POA	POA
2 X 1	\$83.33	\$132.89
2 X 1 1/2	\$58.67	\$64.56
2 1/2 X 1	\$124.67	\$136.67
2 1/2 X 1 1/2	\$104.44	\$136.67
2 1/2 X 2	\$64.29	\$68.67
3 X 1	\$134.44	\$188.89
3 X 1 1/2	\$127.78	\$196.67
3 X 2	\$92.67	\$138.89
3 X 2 1/2	\$92.67	\$138.89
4 X 1 1/2	\$231.11	\$288.89
4 X 2	\$231.11	\$295.56
4 X 2 1/2	\$231.11	\$295.56
4 X 3	\$148.56	\$146.44
6 X 2	\$555.56	\$777.78
6 X 3	\$555.56	\$425.14
6 X 4	\$555.56	\$425.14

### E7WWCS - SHORT CLAMP BRANCH TEE

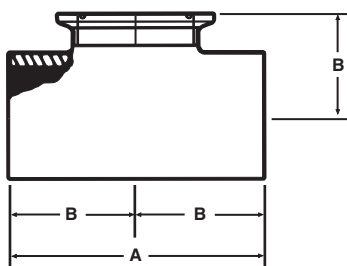

Size Tube OD	T304	T316L
1	POA	POA
1 1/2	POA	POA
2	POA	POA
2 1/2	POA	POA
3	POA	POA
4	POA	POA

## E7RWWCS - REDUCING SHORT CLAMP BRANCH TEE

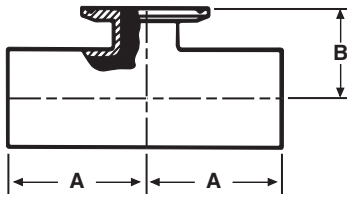

Size Tube OD	T304	T316L
3/4 X 1/2	N/A	POA
1 X 1/2	N/A	POA
1 X 3/4	N/A	POA
1 1/2 X 1/2	N/A	POA
1 1/2 X 3/4	N/A	POA
1 1/2 X 1	N/A	POA
2 X 1/2	N/A	POA
2 X 1 3/4	N/A	POA
2 X 1	N/A	POA
2 X 1 1/2	N/A	POA
2 1/2 X 1/2	N/A	POA
2 1/2 X 3/4	N/A	POA
2 1/2 X 1	N/A	POA
2 1/2 X 1 1/2	N/A	POA
2 1/2 X 2	N/A	POA
3 X 1/2	N/A	POA
3 X 3/4	N/A	POA
3 X 1	N/A	POA
3 X 1 1/2	N/A	POA
3 X 2	N/A	POA
3 X 2 1/2	N/A	POA
4 X 1/2	N/A	POA
4 X 3/4	N/A	POA
4 X 1	N/A	POA
4 X 1 1/2	N/A	POA
4 X 2	N/A	POA
4 X 2 1/2	N/A	POA
4 X 3	N/A	POA
6 X 4	N/A	POA

## E7WWC - TEE WELD X WELD X CLAMP

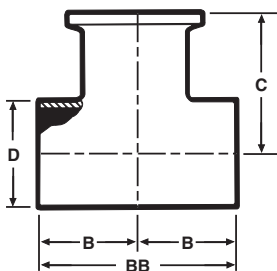

Size Tube OD	T304	T316L
1	\$88.11	\$97.89
1 1/2	\$91.11	\$101.22
2	\$97.89	\$108.78
2 1/2	\$116.67	\$130.00
3	\$133.33	\$148.89
4	\$172.22	\$222.84
6	POA	POA



# WELD FITTINGS

## STAINLESS STEEL FITTINGS PRICE BOOK

### E7WWT - TEE WELD X WELD X THREAD

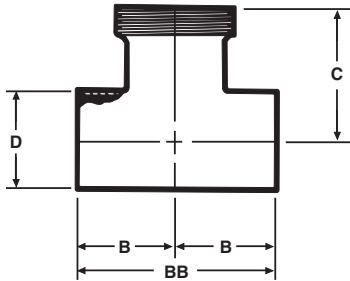

Size Tube OD	T304	T316L
1	\$88.11	\$97.89
1 1/2	\$91.11	\$101.22
2	\$97.89	\$108.78
2 1/2	\$118.09	\$144.89
3	\$157.33	\$185.33
4	\$220.27	\$273.65

### E7WCW - TEE WELD X CLAMP X WELD

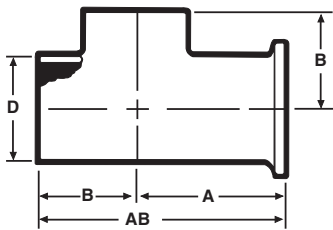

Size Tube OD	T304	T316L
1	\$88.11	\$97.89
1 1/2	\$91.11	\$101.22
2	\$97.89	\$108.78
2 1/2	\$116.67	\$130.00
3	\$183.78	\$160.22
4	\$189.58	\$232.69
6	POA	POA

### E7WTW - TEE THREADED ONE END - WELD X THREAD X WELD

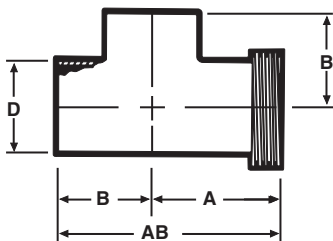

Size Tube OD	T304	T316L
1	\$88.11	\$97.98
1 1/2	\$91.11	\$101.22
2	\$97.89	\$108.78
2 1/2	\$116.67	\$144.89
3	\$157.33	\$185.33
4	\$219.89	\$273.65

# WELD FITTINGS

## STAINLESS STEEL FITTINGS PRICE BOOK

### E7WCC - TEE WELD X CLAMP X CLAMP

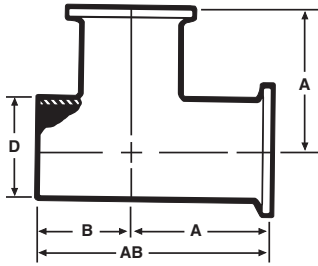

Size Tube OD	T304	T316L
1	\$97.00	\$107.78
1 1/2	\$104.44	\$114.44
2	\$111.11	\$123.33
2 1/2	\$134.44	\$148.89
3	\$159.31	\$186.73
4	\$222.40	\$271.89
6	POA	POA

### E7WTT - TEE WELD X THREAD X THREAD

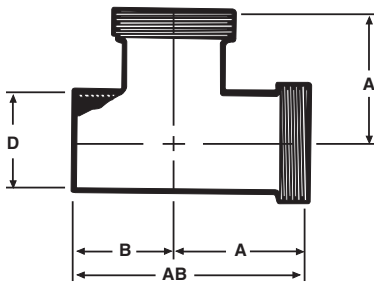

Size Tube OD	T304	T316L
1	\$97.00	\$107.78
1 1/2	\$102.78	\$114.44
2	\$111.11	\$138.42
2 1/2	\$147.42	\$179.71
3	\$214.00	\$230.22
4	\$275.18	\$390.91

### E7CCW - TEE CLAMP X CLAMP X WELD

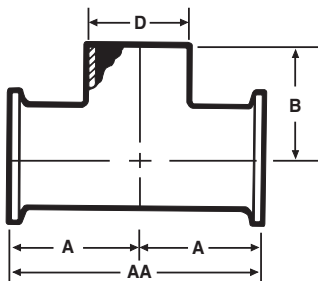

Size Tube OD	T304	T316L
1	\$97.00	\$143.78
1 1/2	\$102.78	\$150.22
2	\$111.11	\$155.11
2 1/2	\$199.56	\$216.44
3	\$159.31	\$253.33
4	\$222.40	\$346.67
6	POA	POA

# WELD FITTINGS

## STAINLESS STEEL FITTINGS PRICE BOOK

### E7TTW - TEE THREAD X THREAD X WELD

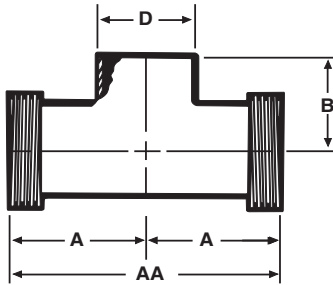

Size Tube OD	T304	T316L
1	\$97.00	\$137.78
1 1/2	\$102.78	\$144.67
2	\$111.11	\$170.00
2 1/2	\$147.42	\$197.56
3	\$193.80	\$230.22
4	\$275.18	\$390.91

### E9WWW - CROSS

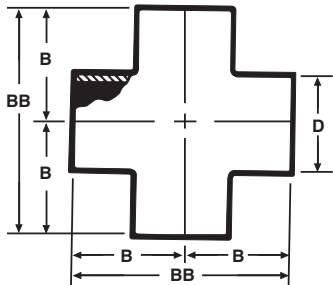

Size Tube OD	T304	T316L
1	\$87.00	\$146.67
1 1/2	\$80.00	\$146.67
2	\$99.78	\$167.13
2 1/2	\$103.56	\$203.91
3	\$144.00	\$271.18
4	\$222.22	\$346.67
6	POA	POA

### E14WA - TYPE A STUB END WITH GROOVES

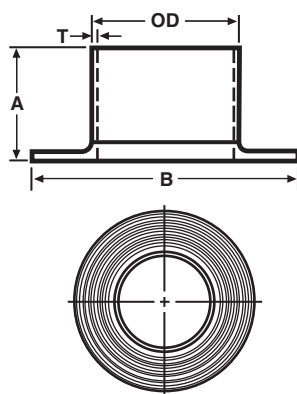

Size Tube OD	T304	T316L
1/2	N/A	\$115.56
3/4	N/A	\$115.56
1	N/A	\$97.33
1 1/4	N/A	POA
1 1/2	N/A	\$97.33
2	N/A	\$124.44
2 1/2	N/A	\$136.67
3	N/A	\$200.00
4	N/A	\$300.00
6	N/A	\$757.78

### E16W - WELD CAP

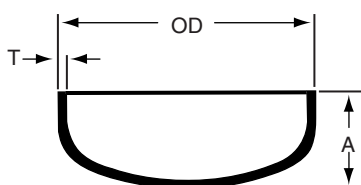

Size Tube OD	T304	T316L
1	\$26.67	\$28.89
1 1/4	POA	POA
1 1/2	\$28.89	\$31.11
2	\$30.00	\$35.22
2 1/2	\$35.56	\$40.00
3	\$53.78	\$51.56
4	\$59.33	\$62.22
6	POA	\$355.56

# WELD FITTINGS

## STAINLESS STEEL FITTINGS PRICE BOOK

### E28WA - 45° LATERAL

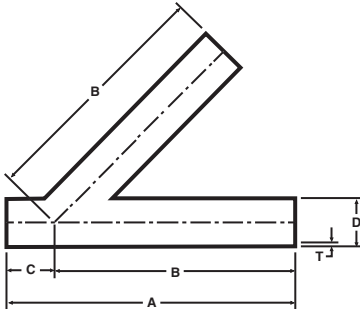

Size Tube OD	T304	T316L
1	\$222.22	\$261.11
1 1/2	\$242.22	\$261.11
2	\$277.78	\$305.56
2 1/2	\$311.11	\$366.67
3	\$344.44	\$413.31
4	\$555.56	\$655.56
6	\$1,500.00	\$2,157.78

### E28WB - TRUE Y

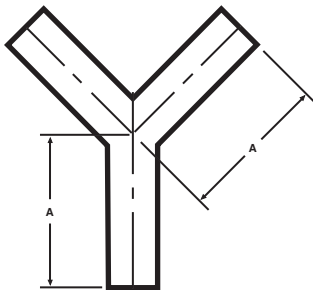

Size Tube OD	T304	T316L
1	\$222.22	\$261.11
1 1/2	\$222.22	\$261.11
2	\$257.78	\$305.56
2 1/2	\$311.11	\$366.67
3	\$344.44	\$405.56
4	\$555.56	\$877.78
6	\$1,500.00	\$2,177.78

### E28RWA - 45° REDUCING LATERAL

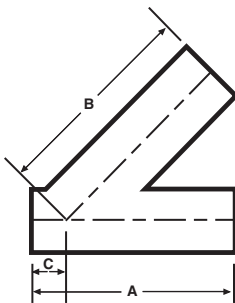

Size Tube OD	T304	T316L
1 1/2 X 1	POA	POA
2 X 1	POA	POA
2 X 1 1/2	POA	POA
2 1/2 X 2	POA	POA
3 X 1	POA	POA
3 X 1 1/2	POA	POA
3 X 2	POA	POA
3 X 2 1/2	POA	POA
4 X 1	POA	POA
4 X 1 1/2	POA	POA
4 X 2	POA	POA
4 X 2 1/2	POA	POA
4 X 3	POA	POA

# WELD FITTINGS

## STAINLESS STEEL FITTINGS PRICE BOOK

### E31WW - CONCENTRIC REDUCER

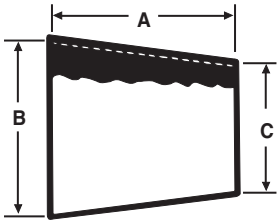

Size Tube OD	T304	T316L
3/4 X 1/2	N/A	\$74.44
1 X 1/2	N/A	\$68.89
1 X 3/4	N/A	\$55.56
1 1/2 X 1/2	N/A	\$100.67
1 1/2 X 3/4	N/A	\$82.22
1 1/2 X 1	\$24.02	\$29.38
1 1/2 X 1 1/4	\$24.02	\$96.89
2 X 1	\$44.36	\$63.78
2 X 1 1/4	N/A	\$133.33
2 X 1 1/2	\$25.11	\$34.16
2 1/2 X 1 1/2	\$42.22	\$72.89
2 1/2 X 2	\$29.30	\$43.24
3 X 1 1/2	\$76.56	\$106.51
3 X 2	\$43.06	\$54.47
3 X 2 1/2	\$51.44	\$87.90
4 X 2	\$116.44	\$153.00
4 X 2 1/2	\$128.89	\$144.00
4 X 3	\$63.90	\$88.02
6 X 2	\$655.56	\$700.00
6 X 3	\$172.58	\$244.19
6 X 4	\$182.62	\$205.43

### E31CW - CONCENTRIC REDUCER CLAMP X WELD

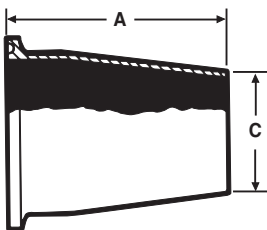

Size Tube OD	T304	T316L
1 1/2 X 1	\$65.22	\$77.78
2 X 1 1/2	\$76.67	\$106.67
2 1/2 X 1 1/2	\$84.44	\$115.56
2 1/2 X 2	\$99.56	\$102.22
3 X 2	\$122.22	\$128.89
3 X 2 1/2	\$134.44	\$140.00
4 X 2	\$229.91	\$235.56
4 X 2 1/2	\$185.75	\$197.78
4 X 3	\$175.56	\$182.22
6 x 4	\$507.67	\$555.56

# WELD FITTINGS

## STAINLESS STEEL FITTINGS PRICE BOOK

### E31PW - CONCENTRIC REDUCER PLAIN BEVEL X WELD

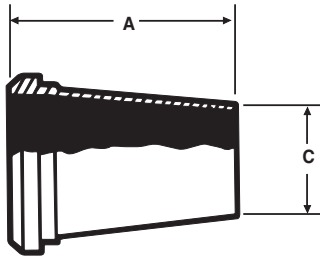

Size Tube OD	T304	T316L
1 1/2 X 1	\$70.44	\$77.78
2 X 1 1/2	\$100.00	\$106.67
2 1/2 X 1 1/2	\$90.11	\$115.56
2 1/2 X 2	\$94.89	\$102.22
3 X 2	\$128.89	\$128.89
3 X 2 1/2	\$141.11	\$140.00
4 X 2	\$221.91	\$235.56
4 X 2 1/2	\$205.44	\$220.00
4 X 3	\$183.33	\$188.89

### E32WW - ECCENTRIC REDUCER

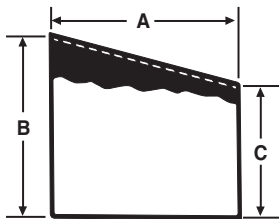

Size Tube OD	T304	T316L
3/4 X 1/2	N/A	\$108.89
1 X 1/2	N/A	\$137.78
1 X 3/4	N/A	\$142.23
1 1/2 X 1/2	N/A	\$188.89
1 1/2 X 3/4	N/A	\$188.89
1 1/2 X 1	\$38.98	\$44.33
1 1/2 X 1 1/4	POA	POA
2 X 1	\$92.27	\$91.11
2 X 1 1/4	POA	POA
2 X 1 1/2	\$40.53	\$50.58
2 1/2 X 1	\$161.12	\$282.23
2 1/2 X 1 1/2	\$66.44	\$97.78
2 1/2 X 2	\$44.80	\$53.47
3 X 2	\$72.50	\$71.94
3 X 2 1/2	\$74.74	\$92.54
4 X 2	\$168.89	\$181.22
4 X 2 1/2	\$139.33	\$173.43
4 X 3	\$86.69	\$115.58
6 X 2	\$688.89	\$777.78
6 X 3	\$366.67	\$422.22
6 X 4	\$366.67	\$422.22

# WELD FITTINGS

## STAINLESS STEEL FITTINGS PRICE BOOK

### E32CW - ECCENTRIC REDUCER CLAMP X WELD

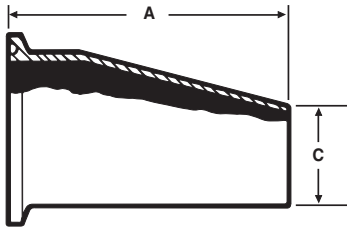

Size Tube OD	T304	T316L
1 1/2 X 1	\$80.56	\$166.89
2 X 1 1/2	\$84.33	\$124.44
2 1/2 X 1 1/2	\$102.00	\$141.11
2 1/2 X 2	\$105.00	\$174.44
3 X 2	\$133.33	\$204.44
3 X 2 1/2	\$158.89	\$216.67
4 X 2	\$295.47	\$321.11
4 X 2 1/2	\$231.18	\$305.56
4 X 3	\$206.67	\$417.78
6 X 4	POA	POA

### E17WW-6L - TUBE X PIPE ADAPTER

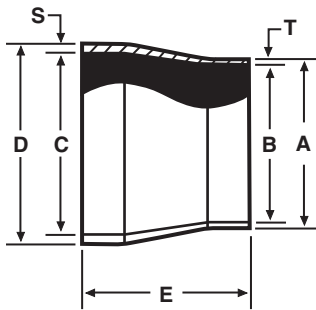

Size Tube OD	SCH 5	SCH 10	SCH 40
1/2	\$48.89	\$54.44	\$58.11
3/4	\$48.89	\$54.44	\$58.11
1	\$64.00	\$69.33	\$62.22
1 1/2	\$64.00	\$69.33	\$68.56
2	\$74.89	\$80.44	\$77.78
2 1/2	\$88.22	\$95.56	\$90.89
3	\$94.00	\$100.00	\$96.11
4	\$188.89	\$188.89	\$188.89
6	\$420.00	\$420.00	\$420.00



## BEVEL SEAT FITTINGS....

Bevel Seat Fittings are used on process equipment and piping to ensure rigidity of the system. Bevel Seat Unions consist of a Threaded Bevel Ferrule mated with a Plain Bevel Ferrule. Both are offered in T304 and T316L material. Hex Union Nuts made of only T304 material are used to complete the union. Gaskets for VNE's Bevel Seat Unions are not required for positive shut-off. However, gaskets may be purchased upon request.

VNE's Bevel Seat Fittings meet all 3A requirements and are available in 1" through 4" sizes.

## BEVEL SEAT SPECIFICATIONS....

**Size Range:** 1" OD through 4" OD

**Materials:** T304  
T316L

**Finish:** No. 7 - ID & OD  
No. 5 - OD only  
No. 3 - ID only  
No. 1 - unpolished

## ORDERING SPECIFICATIONS....

**Specify:**

- Quantity
- Product description or Part No.
- Size
- Material Type
- Polish Requirements

## LIMITED WARRANTY....

VNE Corporation products are warranted to be free from defects in material and workmanship for a period of one year from the date of shipment. Any product that proves to be defective shall be repaired or replaced at the option of VNE, providing it has been used as recommended and in strict accordance with recognized piping practices, and that has not been subject to extraordinary service, such as encountered under severe corrosive or abrasive conditions.

VNE makes no warranties, express or implied, other than those listed above.

VNE shall not be liable for any consequential, indirect, incidental or contingent damages.

## VNE CORPORATION

P.O. Box 1698 • 1149 Barberry Drive • Janesville, WI 53547

TEL: 608-756-4930 • FAX: 608-756-3643 • 1-800-356-1111 • Web site: [vnestainless.com](http://vnestainless.com)



# INDUSTRY CROSS - REFERENCE

STAINLESS STEEL FITTINGS  
PRODUCT CATALOG

## BEVEL SEAT TYPE

VNE	ALFA LAVAL	WAUKESHA / SPX	BRADFORD	STEEL & O'BRIEN
2C	2C	2C	B2C	2C
2E	2E	2E	B2E	2E
2F	2F	2F	B2F	2F
2F-31	2F-31	2F-31	2F-31	2F-31
2K	2K	2K	2K	2K
2P	2P	2P	B2P	2P
7	7	7	7	7
7A	7A	7A	7A	7A
7B	7B	7B	7B	7B
9	9	9	9	9
9A	9A	9A	9A	9A
13H	13H	13H	13H	13H
14	14	14	14	14
14A	L14A7	14A	14A	14A
14AHR	14AHR	14AHR	14AHR	14AHR
14AHT	14AHT	14AHT	14AHT	14AHT
14R	14R	14R	14R	14R
14W	14W	14W	14W	14W
14-22	14-22	14-22	14-22	14-18
14WL	14WL	14WL	14WL	14WL
14-19	14-19	21F	14-19	14-19
14PR	14PRF	14RW	14PRF	14++
15	15	15	15	15
15TR	15TRF	15RW	15TRF	15++
15A	L15A7	15A	15A	15A
15AHR	15AHR	15AHR	15AHR	15AHR
15AHT	15AHT	15AHT	15AHT	15AHT
15R	15R	15R	15R	15R
15W	15W	15W	15W	15W
15WL	15WL	15WL	15WL	15WL
16A	16A	16A	16A	16A
21	21	21	21	21
23B	23B	23B	23B	23B
22	22	22	22	22
31TT	31TT	31TT	B31TT	31TT
31TP	31TP	31TP	B31TP	31TP
31-14F	31-14F	31-14F	B3114F	31-14F
31-15F	31-15F	31-15F	B3115F	31-15F
32-14F	32-14F	32-14F	B3214F	32-14F
32-15F	32-15F	32-15F		32-15F

# BEVEL SEAT FITTINGS

STAINLESS STEEL FITTINGS  
PRICE BOOK

## 2C - 90° ELBOW THREADED

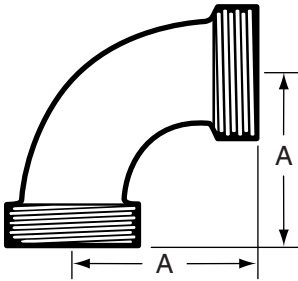

Size Tube OD	T304	T316L
1	\$60.43	\$77.78
1 1/2	\$56.27	\$80.00
2	\$67.60	\$86.30
2 1/2	\$91.60	\$158.47
3	\$123.73	\$223.67
4	\$213.33	\$386.00

## 2E - 90° ELBOW BEVEL SEAT WITH 13H NUT

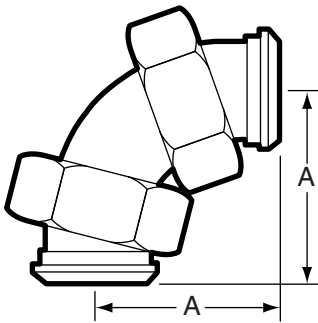

Size Tube OD	T304	T316L
1	\$124.44	\$141.00
1 1/2	\$135.33	\$179.56
2	\$173.00	\$237.78
2 1/2	\$182.00	\$281.00
3	\$255.56	\$334.00
4	\$436.00	\$644.44

## 2F - 90° ELBOW THREADED X 13H NUT

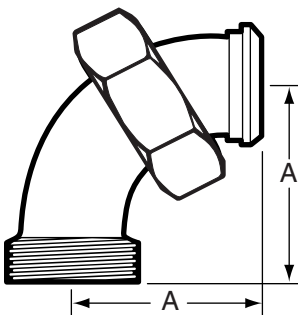

Size Tube OD	T304	T316L
1	\$71.09	\$102.58
1 1/2	\$77.78	\$104.44
2	\$95.44	\$124.00
2 1/2	\$122.22	\$177.76
3	\$152.04	\$243.02
4	\$254.84	\$466.00

## 2K - 45° ELBOW THREADED

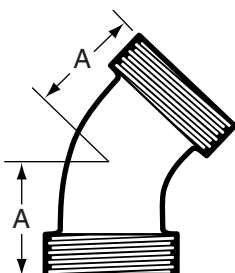

Size Tube OD	T304	T316L
1	\$62.44	\$88.42
1 1/2	\$74.22	\$90.00
2	\$91.78	\$112.95
2 1/2	\$123.56	\$150.71
3	\$153.33	\$215.96
4	\$175.31	\$400.64

# BEVEL SEAT FITTINGS

## 2P - 45° ELBOW 13H NUT X THREAD

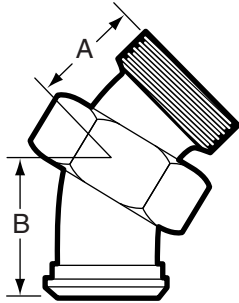

Size Tube OD	T304	T316L
1	\$71.09	\$102.58
1 1/2	\$77.78	\$104.44
2	\$95.44	\$125.29
2 1/2	\$122.22	\$177.76
3	\$152.04	\$243.02
4	\$254.84	\$466.00

## 7 - TEE ALL ENDS THREADED

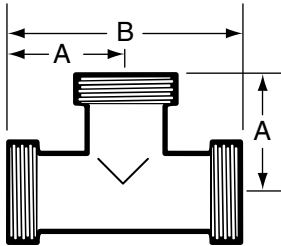

Size Tube OD	T304	T316L
1	\$100.56	\$111.00
1 1/2	\$109.89	\$115.56
2	\$126.33	\$131.11
2 1/2	\$162.00	\$170.22
3	\$169.56	\$208.87
4	\$264.34	\$321.80

## 7A - TEE THREADED X THREADED X 13H NUT

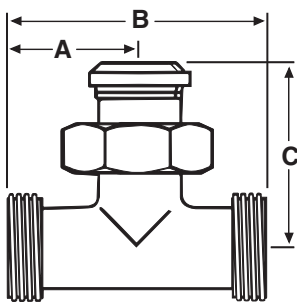

Size Tube OD	T304	T316L
1	\$105.00	\$136.27
1 1/2	\$126.00	\$177.67
2	\$146.89	\$183.07
2 1/2	\$186.44	\$251.44
3	\$215.89	\$329.96
4	\$337.22	\$609.09

## 7B - TEE THREADED X 13H NUT X THREADED

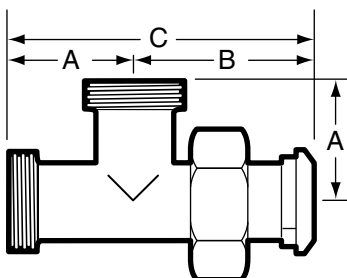

Size Tube OD	T304	T316L
1	\$105.00	\$136.26
1 1/2	\$126.00	\$177.67
2	\$146.89	\$183.07
2 1/2	\$186.44	\$251.44
3	\$215.89	\$329.95
4	\$337.22	\$609.09

# BEVEL SEAT FITTINGS

STAINLESS STEEL FITTINGS  
PRICE BOOK

## 9 - CROSS THREADED

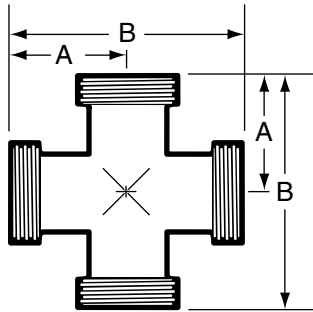

Size Tube OD	T304	T316L
1	\$194.22	\$283.40
1 1/2	\$212.05	\$298.67
2	\$253.44	\$388.80
2 1/2	\$349.47	\$554.36
3	\$403.89	\$751.96
4	\$746.67	\$1,271.13

## 13H - HEX UNION NUT

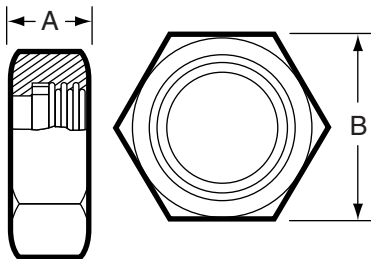

Size Tube OD	T304	T316L
1	\$9.56	N/A
1 1/2	\$14.00	N/A
2	\$17.56	N/A
2 1/2	\$25.56	N/A
3	\$31.12	N/A
4	\$56.38	N/A

## 14 - PLAIN RECESSED FERRULE

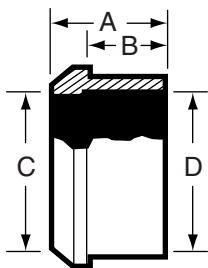

Size Tube OD	T304	T316L
1	N/A	\$49.22
1 1/2	N/A	\$46.87
2	N/A	\$62.78
2 1/2	N/A	\$100.11
3	N/A	\$116.82
4	N/A	\$198.29

## 14R - PLAIN RECESSLESS FERRULE (Expanding)

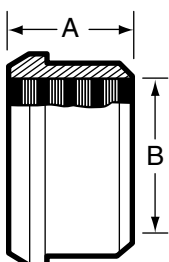

Size Tube OD	T304	T316L
1	\$10.20	\$13.60
1 1/2	\$10.20	\$13.60
2	\$13.38	\$17.82
2 1/2	\$17.18	\$36.11
3	\$21.82	\$39.70
4	\$34.29	\$83.20

# BEVEL SEAT FITTINGS

STAINLESS STEEL FITTINGS  
PRICE BOOK

## 14A - PLAIN WELDING FERRULE

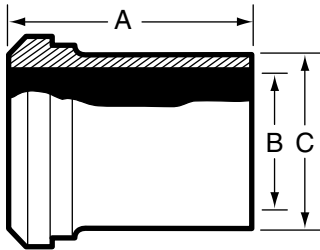

Size Tube OD	T304	T316L
1	\$9.71	\$17.10
1 1/2	\$11.11	\$16.60
2	\$12.10	\$19.40
2 1/2	\$19.50	\$30.00
3	\$24.70	\$39.60
4	\$42.80	\$68.60

## 14PR - SHORT PLAIN WELDING FERRULE

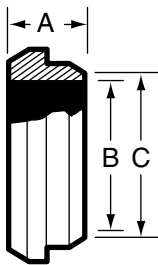

Size Tube OD	T304	T316L
1	\$6.60	\$12.50
1 1/2	\$7.11	\$11.60
2	\$9.00	\$16.20
2 1/2	\$15.02	\$29.50
3	\$19.47	\$37.30
4	\$30.69	\$63.60

## 14W - TANK WELDING PLAIN FERRULE

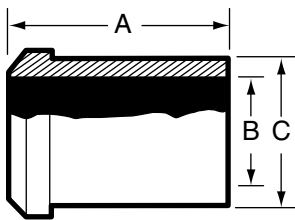

Size Tube OD	T304	T316L
1	\$63.33	\$84.44
1 1/2	\$55.33	\$91.11
2	\$65.33	\$106.67
2 1/2	\$111.11	\$193.00
3	\$137.78	\$225.00
4	\$166.67	\$248.00

## 14WL - LONG PLAIN WELDING FERRULE

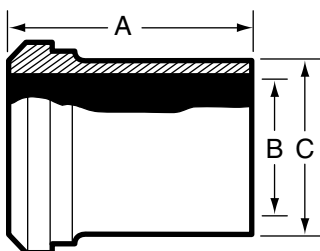

Size Tube OD	T304	T316L
1	\$51.78	\$60.89
1 1/2	\$53.33	\$64.00
2	\$60.00	\$67.33
2 1/2	\$66.67	\$82.10
3	\$73.70	\$110.00
4	\$111.00	\$165.00

# BEVEL SEAT FITTINGS

STAINLESS STEEL FITTINGS  
PRICE BOOK

## 15 - THREADED RECESSED FERRULE

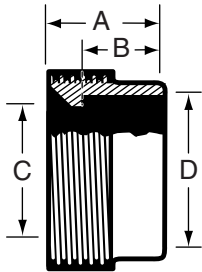

Size Tube OD	T304	T316L
1	N/A	POA
1 1/2	N/A	POA
2	N/A	POA
2 1/2	N/A	POA
3	N/A	POA
4	N/A	POA

## 15A - THREADED WELDING FERRULE

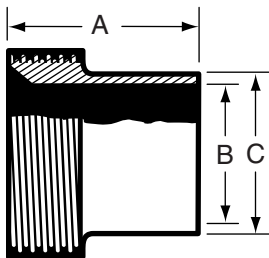

Size Tube OD	T304	T316L
1	\$13.00	\$35.10
1 1/2	\$18.33	\$32.10
2	\$20.90	\$35.30
2 1/2	\$31.33	\$65.80
3	\$41.22	\$82.00
4	\$61.07	\$174.00

## 15R - THREADED RECESSLESS FERRULE (Expanding)

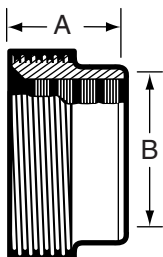

Size Tube OD	T304	T316L
1	\$13.30	\$44.33
1 1/2	\$14.56	\$48.67
2	\$18.20	\$59.42
2 1/2	\$24.84	\$82.89
3	\$29.36	\$104.00
4	\$46.60	\$155.33

## 15TR - SHORT THREADED WELDING FERRULE

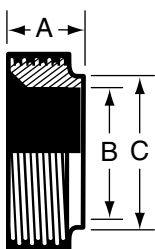

Size Tube OD	T304	T316L
1	\$8.33	\$19.22
1 1/2	\$8.33	\$17.51
2	\$11.50	\$29.71
2 1/2	\$17.71	\$41.22
3	\$22.60	\$58.86
4	\$36.00	\$121.38

# BEVEL SEAT FITTINGS

STAINLESS STEEL FITTINGS  
PRICE BOOK

## 15W - TANK WELDING FERRULE

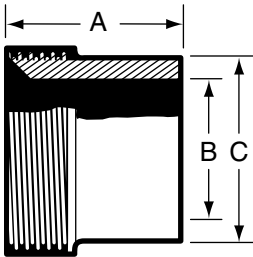

Size Tube OD	T304	T316L
1	\$41.10	\$57.10
1 1/2	\$38.90	\$57.11
2	\$55.70	\$82.50
2 1/2	\$81.10	\$122.00
3	\$91.10	\$136.00
4	\$168.00	\$207.00

## 15WL - LONG WELDING FERRULE

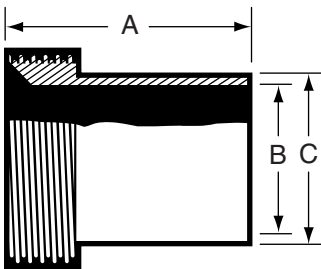

Size Tube OD	T304	T316L
1	\$37.90	\$46.60
1 1/2	\$37.91	\$46.60
2	\$44.90	\$66.80
2 1/2	\$64.20	\$95.50
3	\$83.80	\$125.00
4	\$124.00	\$188.00

## 16A - PLAIN CAP



Size Tube OD	T304	T316L
1	\$5.04	\$13.50
1 1/2	\$8.22	\$13.20
2	\$11.50	\$20.50
2 1/2	\$16.31	\$32.50
3	\$22.90	\$37.80
4	\$42.80	\$55.50

## 23B - TAPPED THERMOMETER CAP

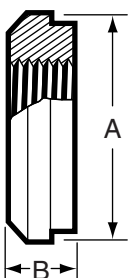

Size Tube OD	T304	T316L
1	\$33.90	\$87.22
1 1/2	\$33.90	\$84.56
2	\$55.40	\$140.96
2 1/2	\$69.20	\$174.96
3	\$115.00	\$291.60
4	\$213.00	\$368.22

# BEVEL SEAT FITTINGS

## 14AHR - RUBBER HOSE ADAPTER

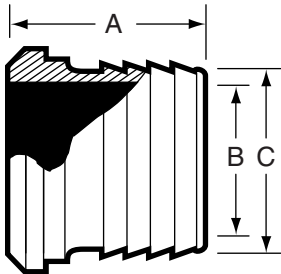

Size Tube OD	T304	T316L
1	\$55.00	\$96.11
1 1/2	\$55.30	\$96.11
2	\$80.00	\$136.16
2 1/2	\$128.00	\$192.25
3	\$147.00	\$312.35
4	\$167.00	\$560.69

## 14AHT - TYGON HOSE ADAPTER

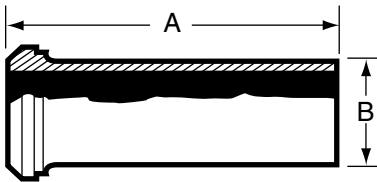

Size Tube OD	T304	T316L
1	\$31.10	\$120.13
1 1/2	\$31.11	\$120.13
2	\$40.70	\$143.05
2 1/2	\$60.90	\$200.22
3	\$75.50	\$246.00
4	\$101.00	\$411.93

## 15AHR - THREADED RUBBER HOSE ADAPTER

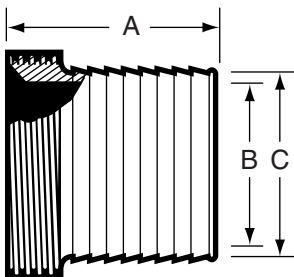

Size Tube OD	T304	T316L
1	\$80.90	\$174.80
1 1/2	\$80.91	\$172.20
2	\$88.80	\$238.40
2 1/2	\$117.00	\$333.78
3	\$142.00	\$381.40
4	\$175.00	\$456.87

## 15AHT - THREADED TYGON HOSE ADAPTER

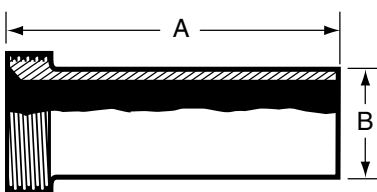

Size Tube OD	T304	T316L
1	\$51.20	\$63.89
1 1/2	\$51.20	\$63.89
2	\$62.02	\$68.67
2 1/2	\$92.49	\$94.78
3	\$114.58	\$118.89
4	\$159.00	\$182.22



# BEVEL SEAT FITTINGS

STAINLESS STEEL FITTINGS  
PRICE BOOK

## 14-22 - ADAPTER 13H NUT X FNPT

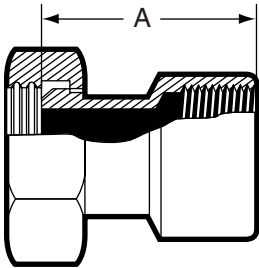

Size Tube OD	T304	T316L
1	\$111.11	\$157.78
1 1/2	\$111.11	\$157.78
2	\$124.44	\$204.44
2 1/2	\$202.22	\$266.67
3	\$268.89	\$430.00
4	\$413.33	\$522.22

## 14-19 - ADAPTER 13H NUT X MNPT

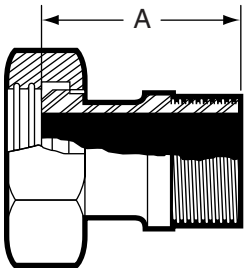

Size Tube OD	T304	T316L
1	\$108.89	\$130.00
1 1/2	\$108.89	\$136.67
2	\$131.11	\$161.11
2 1/2	\$210.00	\$235.56
3	\$255.56	\$301.11
4	\$317.78	\$423.33

## 21 - ADAPTER ACME THREAD X MNPT

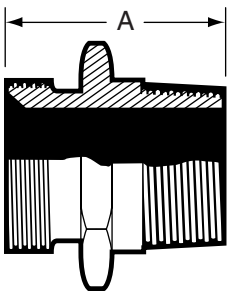

Size Tube OD	T304	T316L
1	\$71.22	\$102.00
1 1/2	\$71.22	\$102.00
2	\$94.22	\$142.22
2 1/2	\$181.11	\$263.33
3	\$190.00	\$281.11
4	\$237.78	\$356.67

## 22 - ADAPTER ACME THREAD X FNPT

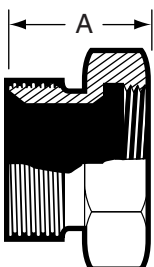

Size Tube OD	T304	T316L
1	\$76.11	\$105.51
1 1/2	\$76.11	\$105.51
2	\$101.00	\$157.78
2 1/2	\$190.00	\$271.11
3	\$208.89	\$290.00
4	\$243.33	\$360.00

# BEVEL SEAT FITTINGS

## 31-14F - CONCENTRIC REDUCER 13H X 13H

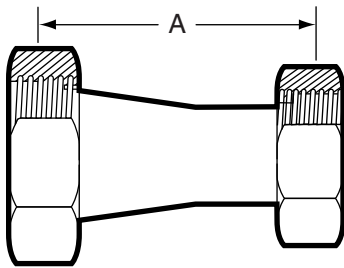

Size Tube OD	T304	T316L
1 1/2 X 1	\$100.00	\$107.58
2 X 1	\$136.11	\$140.29
2 X 1 1/2	\$117.00	\$126.49
2 1/2 X 1 1/2	\$172.44	\$166.60
2 1/2 X 2	\$150.44	\$162.62
3 X 2	\$185.44	\$207.11
3 X 2 1/2	\$183.33	\$199.44
4 X 2 1/2	\$423.89	\$433.33
4 X 3	\$263.89	\$272.22

## 31-15F - CONCENTRIC REDUCER PLAIN BEVEL X THREAD

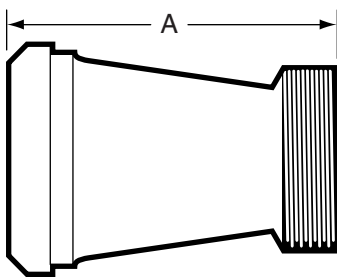

Size Tube OD	T304	T316L
1 1/2 X 1	\$80.78	\$95.89
2 X 1	\$124.33	\$136.33
2 X 1 1/2	\$104.33	\$108.11
2 1/2 X 1 1/2	\$142.89	\$145.33
2 1/2 X 2	\$125.67	\$132.33
3 X 2	\$157.67	\$169.98
3 X 2 1/2	\$160.67	\$174.89
4 X 2 1/2	\$365.67	\$377.78
4 X 3	\$231.11	\$246.67

## 31TT - CONCENTRIC REDUCER THREAD X THREAD

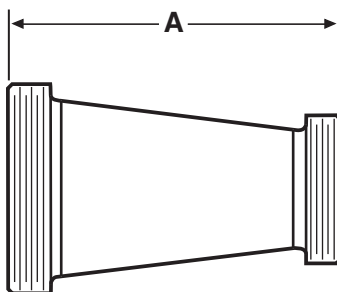

Size Tube OD	T304	T316L
1 1/2 X 1	\$80.44	\$89.38
2 X 1	\$120.22	\$119.47
2 X 1 1/2	\$90.89	\$104.62
2 1/2 X 1 1/2	\$143.44	\$148.11
2 1/2 X 2	\$121.44	\$138.71
3 X 2	\$197.56	\$200.56
3 X 2 1/2	\$195.33	\$189.53
4 X 2 1/2	\$323.89	\$356.45
4 X 3	\$204.44	\$216.67

# BEVEL SEAT FITTINGS

STAINLESS STEEL FITTINGS  
PRICE BOOK

## 31TP - CONCENTRIC REDUCER THREAD X 13H NUT

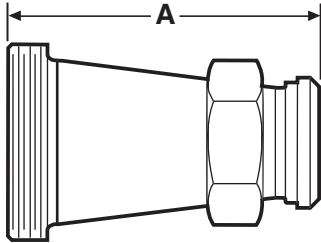

Size Tube OD	T304	T316L
1 1/2 X 1	\$83.22	\$99.40
2 X 1	\$124.56	\$129.49
2 X 1 1/2	\$109.40	\$112.22
2 1/2 X 1 1/2	\$146.11	\$149.80
2 1/2 X 2	\$124.22	\$135.11
3 X 2	\$198.00	\$202.22
3 X 2 1/2	\$196.67	\$200.56
4 X 2	\$330.22	\$333.33
4 X 2 1/2	\$330.22	\$344.44
4 X 3	\$210.09	\$222.22

## 32-14F - ECCENTRIC REDUCER 13H NUT X 13H NUT

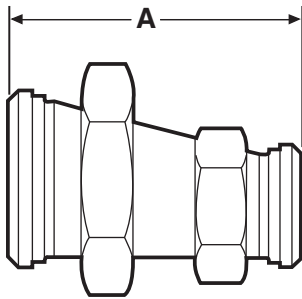

Size Tube OD	T304	T316L
1 1/2 X 1	\$132.78	\$145.22
2 X 1	\$202.67	\$243.00
2 X 1 1/2	\$141.89	\$149.00
2 1/2 X 1 1/2	\$183.78	\$232.89
2 1/2 X 2	\$159.76	\$162.22
3 X 2	\$207.78	\$251.44
3 X 2 1/2	\$179.22	\$200.33
4 X 2	\$320.78	\$412.44
4 X 2 1/2	\$345.44	\$436.38
4 X 3	\$271.22	\$300.00

## 32-15F - ECCENTRIC REDUCER PLAIN BEVEL X THREAD

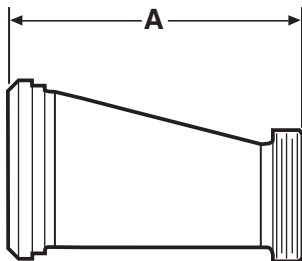

Size Tube OD	T304	T316L
1 1/2 X 1	\$127.56	\$138.78
2 X 1	\$191.00	\$231.89
2 X 1 1/2	\$130.22	\$144.44
2 1/2 X 1 1/2	\$164.56	\$206.00
2 1/2 X 2	\$138.44	\$177.78
3 X 2	\$186.87	\$215.33
3 X 2 1/2	\$163.44	\$183.33
4 X 2	\$267.67	\$351.00
4 X 2 1/2	\$288.89	\$300.00
4 X 3	\$248.56	\$262.67

# BEVEL SEAT FITTINGS

STAINLESS STEEL FITTINGS  
PRICE BOOK

## 32TT - ECCENTRIC REDUCER THREAD X THREAD

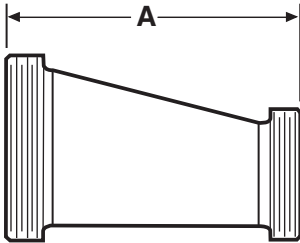

Size Tube OD	T304	T316L
1 1/2 X 1	\$120.33	\$124.11
2 X 1	\$186.89	\$216.22
2 X 1 1/2	\$127.00	\$131.11
2 1/2 X 1 1/2	\$165.11	\$211.56
2 1/2 X 2	\$141.11	\$150.00
3 X 2	\$226.78	\$235.00
3 X 2 1/2	\$198.11	\$205.56
4 X 2	\$231.11	\$361.22
4 X 2 1/2	\$253.44	\$306.33
4 X 3	\$211.11	\$235.33

## 32TP - ECCENTRIC REDUCER THREAD X 13H NUT

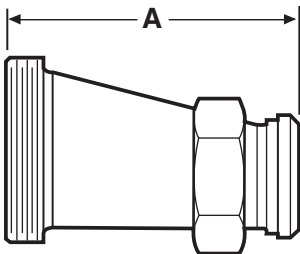

Size Tube OD	T304	T316L
1 1/2 X 1	\$123.11	\$129.78
2 X 1	\$191.33	\$220.11
2 X 1 1/2	\$129.56	\$133.11
2 1/2 X 1 1/2	\$161.33	\$208.78
2 1/2 X 2	\$143.78	\$147.89
3 X 2	\$204.33	\$205.89
3 X 2 1/2	\$182.33	\$188.89
4 X 2	\$241.89	\$338.89
4 X 2 1/2	\$282.00	\$306.44
4 X 3	\$220.00	\$235.67

## JOHN PERRY

### 14PRJP - SHORT PLAIN WELDING FERRULE

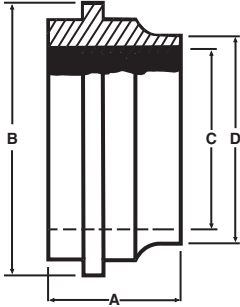

Size Tube OD	T304	T316L
1	N/A	\$26.15
1 1/2	N/A	\$19.66
2	N/A	\$33.00
2 1/2	N/A	\$53.42
3	N/A	\$59.91
4	N/A	\$140.85

### 15TRJP - SHORT THREAD WELDING FERRULE

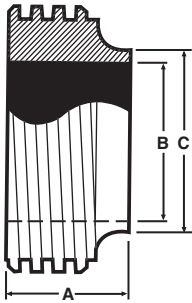

Size Tube OD	T304	T316L
1	N/A	\$32.49
1 1/2	N/A	\$32.49
2	N/A	\$46.71
2 1/2	N/A	\$86.19
3	N/A	\$93.55
4	N/A	\$200.76

### 14AJP - LONG PLAIN WELDING FERRULE

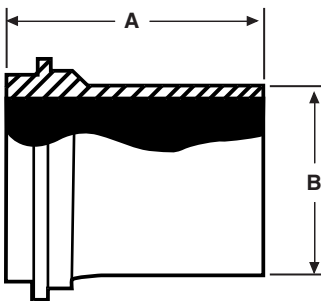

Size Tube OD	T304	T316L
1	N/A	\$43.20
1 1/2	N/A	\$43.20
2	N/A	\$49.09
2 1/2	N/A	\$70.09
3	N/A	\$105.71
4	N/A	\$242.96

## JOHN PERRY

### 15AJP - LONG THREAD WELDING FERRULE

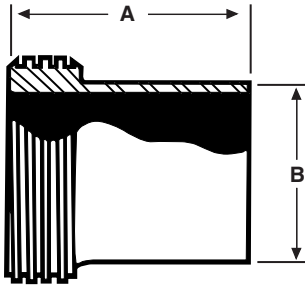

Size Tube OD	T304	T316L
1	N/A	\$67.75
1 1/2	N/A	\$67.75
2	N/A	\$74.53
2 1/2	N/A	\$139.00
3	N/A	\$172.87
4	N/A	\$367.20

### 16AJP - CAP

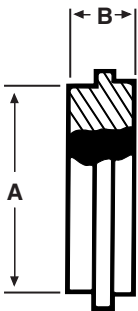

Size Tube OD	T304	T316L
1	N/A	\$16.51
1 1/2	N/A	\$20.78
2	N/A	\$28.51
2 1/2	N/A	\$37.29
3	N/A	\$54.65
4	N/A	\$130.51



## E-LINE FITTINGS....

E-Line Fittings have a male and female interface construction to ensure rigidity of your system.

VNE offers E-Line Fittings in sizes 1" through 6" in T304 and T316L material. VNE offers Polished ID and OD Fittings for immediate shipment. Other polished combinations may be ordered.

Gaskets for E-Line Fittings are available in several different materials, Buna-N, EPDM, Teflon®, and Viton®.

## E-LINE FITTING SPECIFICATIONS....

**Size Range:** 1" OD through 6" OD

**Materials:** T304  
T316L

**Finish:** No. 7 - ID & OD  
No. 5 - OD only  
No. 3 - ID only  
No. 1 - unpolished

## ORDERING SPECIFICATIONS....

**Specify:**

- Quantity
- Product description or Part No.
- Size
- Material Type
- Polish Requirements

## LIMITED WARRANTY....

VNE Corporation products are warranted to be free from defects in material and workmanship for a period of one year from the date of shipment. Any product that proves to be defective shall be repaired or replaced at the option of VNE, providing it has been used as recommended and in strict accordance with recognized piping practices, and that has not been subject to extraordinary service, such as encountered under severe corrosive or abrasive conditions.

VNE makes no warranties, express or implied, other than those listed above.

VNE shall not be liable for any consequential, indirect, incidental or contingent damages.

# INDUSTRY CROSS - REFERENCE

## STAINLESS STEEL FITTINGS PRODUCT CATALOG

### E-LINE TYPE

VNE	ROBERT JAMES	WAUKESHA / SPX	Bradford	Steel & O'Brien
E2CI	RJ2CZ	2CI	B2CI	HDI-2C
E2FI	RJ2FZ	2FI	B2FI	HDI-2F
E2EI	----	2EI	B2EI	HDI-2E
E2KI	RJ2KZ	2KI	B2KI	HDI-2K
E2PI	RJ2PZ	2PI	B2PI	HDI-2P
E7I	RJ7Z	7I	B7I	HDI-7
E7AI	RJ7AZ	7AI	B7AI	----
E7EI	RJ7EZ	7EI	B7EI	----
E7BI	RJ7BZ	7BI	B7BI	----
E9I	RJ9Z	9I	B9I	----
E13IS	RJ13ZS	13IS	13ILH	HDI-13-UD
E13IU	RJ13Z	13IU	13IU	HDI-13-U
E14WI	RJ14WZ	14WI	14WI	14WH
E15WI	RJ15WZ	15WI	15WI	15WH
E14WLI	RJ14WLZ	14WLI	14WLI	14WLH
E15WLI	RJ15WLZ	15WLI	15WLI	15WLH
E14HRI	RJ14HRZ	14HRI	14HRI	----
E14HTI	RJ14HTZ	14HTI	14HTI	----
E15HRI	RJ15HRZ	15HRI	15HRI	----
E15HTI	RJ15HTZ	15HTI	15HTI	----
E17-14I-15I	RJ17-14Z-15Z	17-14I-15I	17-14I-15I	----
E17-15I-15I	RJ17-15Z-15Z	17-15I-15I	17-15I-15I	----
E17-14I-14I	RJ17-14Z-14Z	17-14I-14I	17-14I-14I	----
E17-14I-14	RJ17-14Z-14	17-14I-14	17-14I-14	----
E17-14I-14MP	RJ17-14Z-14MP	17-14I-14MP	17-14I-14MP	----
E17-14I-15	RJ17-14Z-15	17-14I-15	17-14I-15	----
E17-15I-14	RJ17-15Z-14	17-15I-14	17-15I-14	----
E17-15I-15	RJ17-15Z-15	17-15I-15L	17-15I-15	----
E17-15I-14MP	RJ17-15Z-14MP	17-15I-14MP	17-15I-MP	----
E21I-14I	RJ21-14Z	21FI-14I	21I-14I	----
E21I-15I	RJ21-15Z	21F1-15I	22I-15I	----
E22I-14I	RJ22-14Z	22FI-14I	22I-14I	----
E22I-15I	RJ22-15Z	22FI-15I	22I-15I	----
E16AI-14I	RJ16AZ-14Z	16AI-14I	16AI-14I	HDI-16A-14
E16AI-15I	RJ16AZ-15Z	16AI-15I	16AI-15I	HDI-16A-15
E31I-14I	RJ31Z-14Z	31I-14FI	31I-14I	HDI-31-14F
E31I-15I	RJ31Z-15Z	31I-15FI	31I-15I	HDI-31-15F
E31I-15I-14I	RJ31Z-15Z-14Z	----	31I-15I-14I	----
E31I-15I-15I	RJ31Z-15Z-15Z	----	31I-15I-15I	----
E32I-14I	RJ32Z-14Z	32I-14FI	32I-14I	HDI-32-14F
E32I-15I	RJ32Z-15Z	32I-15FI	32I-15I	HDI-32-15F
E14WHI	----	14WHI	14WHI	
E15WHI	----	15WHI	15WHI	



# E-LINE FITTINGS

## STAINLESS STEEL FITTINGS PRICE BOOK

### E2CI - 90° ELBOW FEMALE X FEMALE

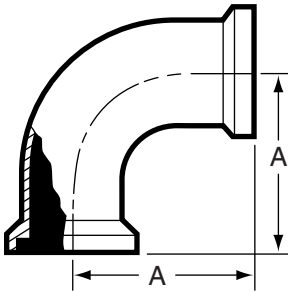

Size Tube OD	T304	T316L
1	\$79.33	\$99.11
1 1/2	\$100.40	\$108.89
2	\$118.00	\$126.78
2 1/2	\$159.44	\$187.56
3	\$185.89	\$312.89
4	\$297.11	\$382.11
6	\$1,277.78	\$1,532.44

### E2FI - 90° ELBOW MALE X FEMALE

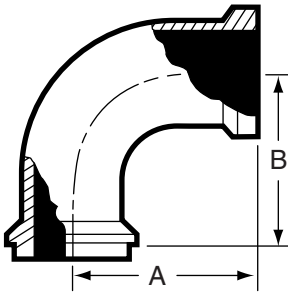

Size Tube OD	T304	T316L
1	\$79.33	\$99.11
1 1/2	\$100.40	\$108.89
2	\$118.00	\$126.78
2 1/2	\$159.44	\$187.56
3	\$185.89	\$312.89
4	\$297.11	\$382.11
6	\$1,277.78	\$1,532.44

### E2EI - 90° ELBOW MALE X MALE

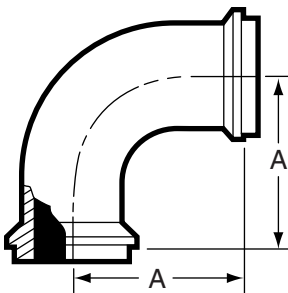

Size Tube OD	T304	T316L
1	\$79.33	\$99.11
1 1/2	\$100.40	\$108.89
2	\$118.00	\$126.78
2 1/2	\$159.44	\$187.56
3	\$185.89	\$312.89
4	\$297.11	\$382.11
6	\$1,277.78	\$1,532.44

### E2KI - 45° ELBOW FEMALE X FEMALE

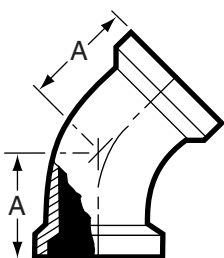

Size Tube OD	T304	T316L
1	\$67.44	\$81.33
1 1/2	\$97.44	\$102.11
2	\$123.89	\$134.89
2 1/2	\$173.11	\$195.33
3	\$202.22	\$326.67
4	\$254.13	\$358.22
6	\$1,195.11	\$1,348.44

# E-LINE FITTINGS

## STAINLESS STEEL FITTINGS PRICE BOOK

### E2PI - 45° ELBOW FEMALE X MALE

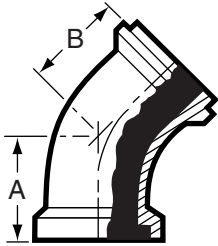

Size Tube OD	T304	T316L
1	\$67.44	\$81.33
1 1/2	\$97.44	\$102.11
2	\$123.89	\$134.89
2 1/2	\$173.11	\$195.33
3	\$202.22	\$326.67
4	\$254.13	\$358.22
6	\$1,195.11	\$1,348.44

### E2HI - 45° ELBOW MALE X MALE

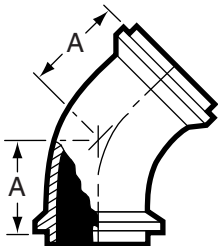

Size Tube OD	T304	T316L
1	\$67.44	\$81.33
1 1/2	\$97.44	\$102.11
2	\$123.89	\$134.89
2 1/2	\$173.11	\$195.33
3	\$202.22	\$326.67
4	\$254.13	\$358.22
6	\$1,195.11	\$1,348.44

### E7I - TEE ALL ENDS FEMALE

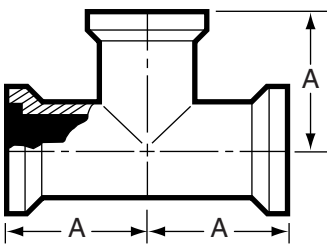

Size Tube OD	T304	T316L
1	\$119.22	\$134.00
1 1/2	\$141.00	\$146.11
2	\$168.89	\$189.67
2 1/2	\$225.33	\$272.89
3	\$257.44	\$446.67
4	\$379.44	\$471.44
6	\$1,964.67	\$2,038.22

### E7AI - TEE FEMALE X FEMALE X MALE

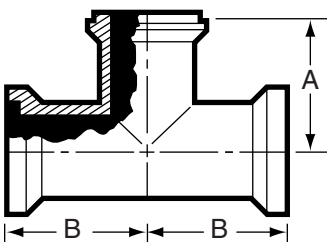

Size Tube OD	T304	T316L
1	\$119.22	\$134.00
1 1/2	\$141.00	\$146.11
2	\$168.89	\$189.67
2 1/2	\$225.33	\$272.89
3	\$257.44	\$446.67
4	\$379.44	\$471.44
6	\$1,964.67	\$2,038.22

# E-LINE FITTINGS

## STAINLESS STEEL FITTINGS PRICE BOOK

### E7BI - TEE MALE X FEMALE X FEMALE

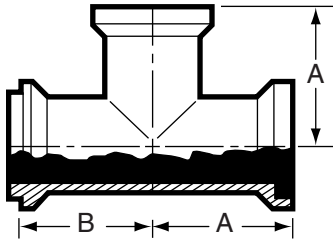

Size Tube OD	T304	T316L
1	\$119.22	\$134.00
1 1/2	\$141.00	\$146.11
2	\$168.89	\$189.67
2 1/2	\$225.33	\$272.89
3	\$257.44	\$446.67
4	\$379.44	\$471.44
6	\$1,964.67	\$2,038.22

### E7EI - TEE MALE X MALE X FEMALE

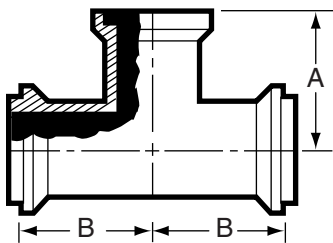

Size Tube OD	T304	T316L
1	\$119.22	\$134.00
1 1/2	\$141.00	\$146.11
2	\$168.89	\$189.67
2 1/2	\$225.33	\$272.89
3	\$257.44	\$446.67
4	\$379.44	\$471.44
6	\$1,964.67	\$2,038.22

### E7HI - TEE ALL ENDS MALE

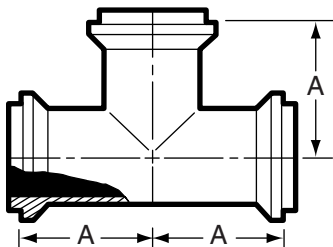

Size Tube OD	T304	T316L
1	\$119.22	\$134.00
1 1/2	\$141.00	\$146.11
2	\$168.89	\$189.67
2 1/2	\$225.33	\$272.89
3	\$257.44	\$446.67
4	\$379.44	\$471.44
6	\$1,964.67	\$2,038.22

### E7RI - REDUCING TEE ALL ENDS FEMALE

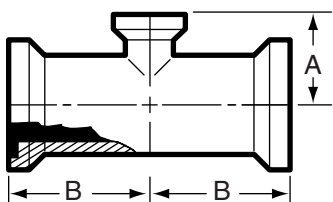

Size Tube OD	T304	T316L
1 1/2 X 1	\$158.33	\$156.67
2 X 1	\$185.44	\$198.22
2 X 1 1/2	\$196.44	\$211.67
2 1/2 X 1 1/2	\$294.44	\$297.89
2 1/2 X 2	\$244.89	\$267.89
3 X 2	\$348.00	\$477.00
3 X 2 1/2	\$341.00	\$467.00
4 X 2	\$688.89	\$933.33
4 X 2 1/2	\$668.00	\$918.00
4 X 3	\$682.00	\$936.00
6 X 3	\$1,668.33	\$1,857.44
6 X 4	\$1,955.56	\$2,000.00

# E-LINE FITTINGS

## STAINLESS STEEL FITTINGS PRICE BOOK

### E9I - CROSS ALL ENDS FEMALE

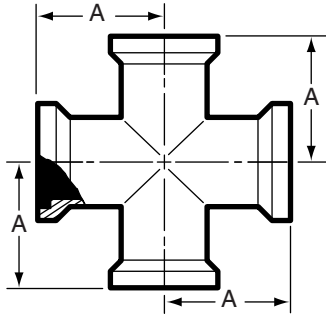

Size Tube OD	T304	T316L
1	\$186.67	\$277.78
1 1/2	\$220.00	\$286.67
2	\$243.33	\$363.78
2 1/2	\$289.89	\$493.33
3	\$362.22	\$719.22
4	\$660.00	\$1111.11
6	\$2,222.22	\$2,817.78

### E14WI - SHORT MALE WELDING FERRULE

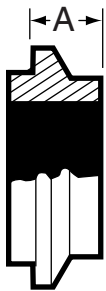

Size Tube OD	T304	T316L
1	\$7.33	\$8.70
1 1/2	\$7.33	\$8.70
2	\$11.31	\$13.80
2 1/2	\$17.78	\$23.22
3	\$26.51	\$36.70
4	\$43.31	\$61.13
6	\$182.00	\$200.45

### E14WLI - LONG MALE WELDING FERRULE

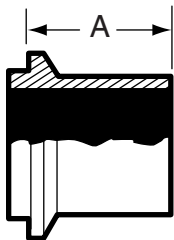

Size Tube OD	T304	T316L
1	\$47.89	\$53.33
1 1/2	\$49.56	\$55.00
2	\$55.89	\$62.22
2 1/2	\$59.11	\$75.00
3	\$78.89	\$100.78
4	\$120.00	\$153.33
6	\$845.05	\$833.33

### E15WI - SHORT FEMALE WELDING FERRULE



Size Tube OD	T304	T316L
1	\$7.89	\$10.20
1 1/2	\$7.89	\$10.40
2	\$13.22	\$16.30
2 1/2	\$18.80	\$26.00
3	\$27.96	\$38.64
4	\$43.31	\$61.13
6	T316L	\$217.78

# E-LINE FITTINGS

## STAINLESS STEEL FITTINGS PRICE BOOK

### E15WLI - LONG FEMALE WELDING FERRULE

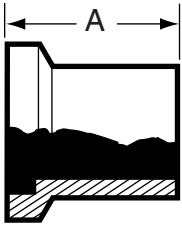

Size Tube OD	T304	T316L
1	\$46.67	\$51.56
1 1/2	\$51.67	\$57.44
2	\$53.33	\$64.44
2 1/2	\$70.78	\$80.44
3	\$85.00	\$107.78
4	\$132.22	\$168.89
6	\$844.44	\$944.44

### E14HRI - MALE RUBBER HOSE ADAPTER

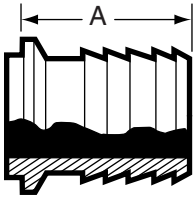

Size Tube OD	T304	T316L
1	\$55.56	\$82.90
1 1/2	\$57.00	\$82.90
2	\$68.33	\$112.22
2 1/2	\$88.33	\$145.56
3	\$125.56	\$206.67
4	\$213.00	\$395.56
6	\$677.78	\$722.22

### E14HTI - MALE TYGON HOSE ADAPTER

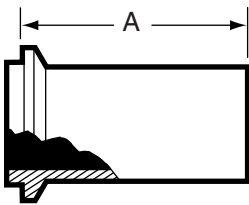

Size Tube OD	T304	T316L
1	\$54.89	\$61.11
1 1/2	\$56.22	\$62.44
2	\$62.33	\$69.22
2 1/2	\$76.44	\$103.00
3	\$82.44	\$121.11
4	\$117.78	\$192.22

### E15HRI - FEMALE RUBBER HOSE ADAPTER

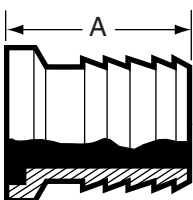

Size Tube OD	T304	T316L
1	\$59.00	\$97.11
1 1/2	\$59.00	\$97.11
2	\$78.33	\$130.00
2 1/2	\$102.56	\$168.89
3	\$146.67	\$238.89
4	\$274.44	\$390.00
6	\$677.78	\$722.22

# E-LINE FITTINGS

## STAINLESS STEEL FITTINGS PRICE BOOK

### E15HTI - FEMALE TYGON HOSE ADAPTER

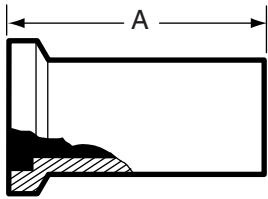

Size Tube OD	T304	T316L
1	\$57.22	\$63.56
1 1/2	\$58.56	\$65.11
2	\$64.67	\$84.00
2 1/2	\$78.56	\$114.44
3	\$87.11	\$145.56
4	\$140.00	\$195.56

### E14WHI - MALE WELD FERRULE

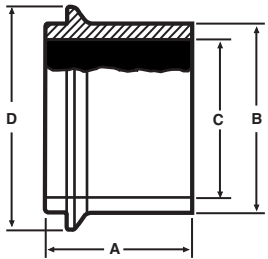

Size Tube OD	T304	T316L
1	N/A	\$63.56
1 1/2	N/A	\$63.56
2	N/A	\$69.11
2 1/2	N/A	\$116.67
3	N/A	\$126.89
4	N/A	\$155.11

### E15WHI - FEMALE WELD FERRULE

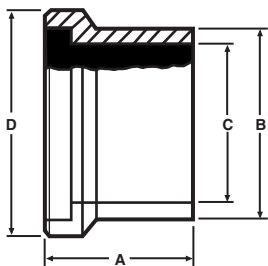

Size Tube OD	T304	T316L
1	N/A	\$66.89
1 1/2	N/A	\$66.89
2	N/A	\$77.33
2 1/2	N/A	\$125.33
3	N/A	\$139.33
4	N/A	\$168.44

### E17-14I-14I - ADAPTER BOTH ENDS MALE

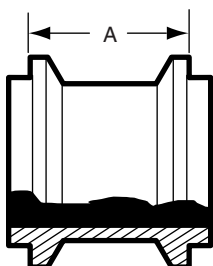

Size Tube OD	T304	T316L
1	\$60.22	\$102.56
1 1/2	\$60.22	\$102.56
2	\$80.11	\$132.22
2 1/2	\$111.00	\$183.33
3	\$244.44	\$377.78
4	\$290.00	\$477.78
6	\$777.78	\$844.44

# E-LINE FITTINGS

## STAINLESS STEEL FITTINGS PRICE BOOK

### E17-14I-15I - ADAPTER MALE X FEMALE

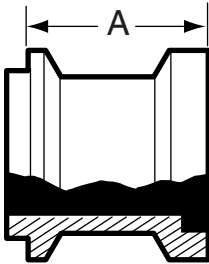

Size Tube OD	T304	T316L
1	\$60.22	\$102.56
1 1/2	\$60.22	\$102.56
2	\$80.11	\$132.22
2 1/2	\$111.00	\$183.33
3	\$244.44	\$400.00
4	\$290.00	\$477.78
6	\$777.78	\$844.44

### E17-15I-15I - ADAPTER BOTH ENDS FEMALE

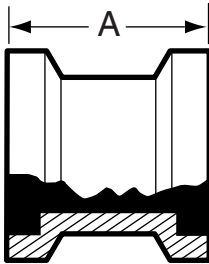

Size Tube OD	T304	T316L
1	\$60.22	\$102.56
1 1/2	\$60.22	\$102.56
2	\$80.11	\$132.22
2 1/2	\$111.00	\$183.33
3	\$244.44	\$400.00
4	\$290.00	\$477.78
6	\$777.78	\$844.44

### E17-14I-14-ADAPTER MALE X 13H NUT

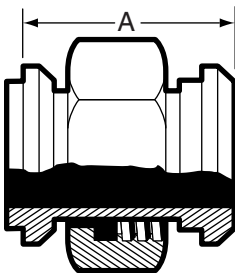

Size Tube OD	T304	T316L
1	\$87.33	\$160.00
1 1/2	\$87.33	\$160.00
2	\$126.67	\$207.78
2 1/2	\$176.67	\$288.89
3	\$232.22	\$381.11
4	\$366.67	\$602.22

### E17-14I-14MP - ADAPTER MALE X CLAMP

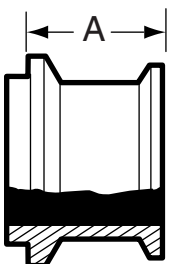

Size Tube OD	T304	T316L
1	\$53.11	\$97.00
1 1/2	\$53.11	\$101.67
2	\$71.44	\$117.78
2 1/2	\$98.11	\$150.00
3	\$126.67	\$204.44
4	\$215.56	\$477.78
6	\$488.89	\$800.00

# E-LINE FITTINGS

## STAINLESS STEEL FITTINGS PRICE BOOK

### E17-14I-15 - ADAPTER MALE X ACME THREAD

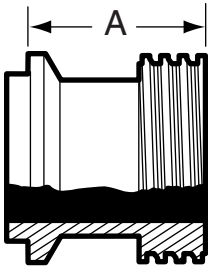

Size Tube OD	T304	T316L
1	\$58.11	\$96.11
1 1/2	\$58.11	\$96.11
2	\$76.56	\$127.78
2 1/2	\$102.67	\$175.56
3	\$126.67	\$206.67
4	\$291.11	\$477.78

### E17-15I-14 - ADAPTER FEMALE X 13H NUT

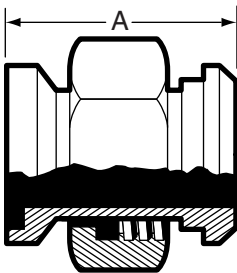

Size Tube OD	T304	T316L
1	\$97.11	\$160.00
1 1/2	\$97.11	\$160.00
2	\$126.67	\$207.78
2 1/2	\$180.00	\$295.56
3	\$238.89	\$381.11
4	\$376.67	\$602.22

### E17-15I-14MP - ADAPTER FEMALE X CLAMP

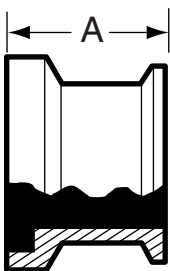

Size Tube OD	T304	T316L
1	\$54.89	\$97.00
1 1/2	\$54.89	\$97.00
2	\$71.44	\$113.33
2 1/2	\$101.22	\$150.00
3	\$126.67	\$204.44
4	\$213.33	\$477.78
6	\$488.89	\$577.78

### E17-15I-15 - ADAPTER FEMALE X ACME THREAD

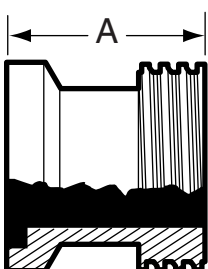

Size Tube OD	T304	T316L
1	\$60.22	\$102.56
1 1/2	\$60.22	\$102.56
2	\$80.11	\$132.22
2 1/2	\$111.00	\$183.33
3	\$244.44	\$400.00
4	\$290.00	\$477.78



# E-LINE FITTINGS

## STAINLESS STEEL FITTINGS PRICE BOOK

### E21I-14I - ADAPTER MALE X MNPT

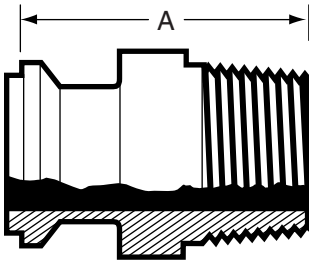

Size Tube OD	T304	T316L
1	\$77.33	\$128.89
1 1/2	\$99.89	\$164.44
2	\$150.00	\$186.67
2 1/2	\$195.56	\$244.44
3	\$253.33	\$320.00
4	\$313.33	\$413.33
6	\$755.56	\$877.78

### E21I-15I - ADAPTER FEMALE X MNPT

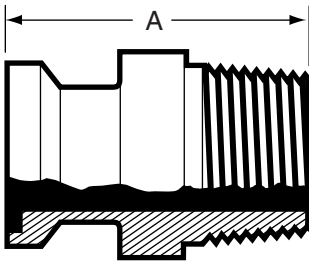

Size Tube OD	T304	T316L
1	\$79.00	\$142.22
1 1/2	\$101.33	\$166.67
2	\$116.67	\$187.78
2 1/2	\$154.44	\$245.56
3	\$201.11	\$414.44
4	\$262.22	\$513.33
6	\$755.56	\$755.56

### E22I-14I - ADAPTER MALE X FNPT

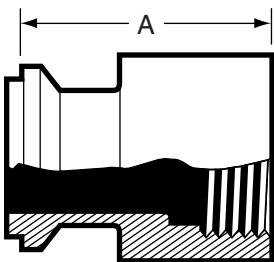

Size Tube OD	T304	T316L
1	\$88.89	\$146.67
1 1/2	\$101.33	\$166.67
2	\$115.56	\$192.22
2 1/2	\$201.11	\$325.56
3	\$260.00	\$425.56
4	\$337.78	\$524.44

### E22I-15I - ADAPTER FEMALE X FNPT

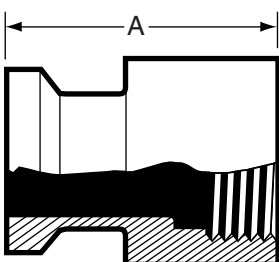

Size Tube OD	T304	T316L
1	\$88.89	\$146.67
1 1/2	\$99.89	\$166.67
2	\$112.22	\$187.78
2 1/2	\$195.56	\$320.00
3	\$253.33	\$414.44
4	\$313.33	\$513.33

# E-LINE FITTINGS

## STAINLESS STEEL FITTINGS PRICE BOOK

### E23BI - THERMOMETER CAP

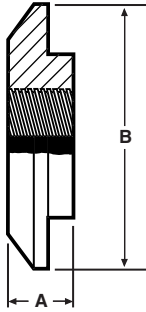

Size Tube OD	T304	T316L
1	\$34.89	\$50.00
1 1/2	\$34.89	\$50.00
2	\$50.33	\$72.56
2 1/2	\$57.11	\$79.78
3	\$94.00	\$135.56
4	\$136.67	\$177.78

### E28AI - LATERAL ALL ENDS FEMALE

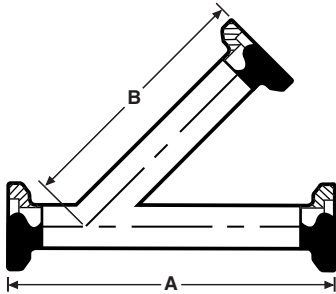

Size Tube OD	T304	T316L
1	\$305.56	\$386.98
1 1/2	\$305.56	\$386.98
2	\$361.11	\$433.33
2 1/2	\$416.67	\$574.22
3	\$505.56	\$671.84
4	\$816.67	\$1142.78
6	\$2,222.22	\$2,777.78

### E28BI - TRUE Y ALL ENDS FEMALE

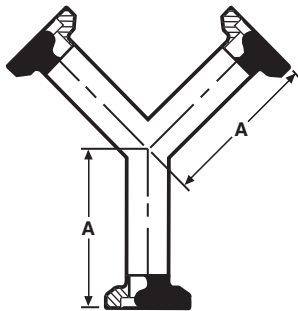

Size Tube OD	T304	T316L
1	\$305.56	\$401.71
1 1/2	\$305.56	\$401.71
2	\$361.11	\$433.33
2 1/2	\$416.67	\$576.04
3	\$505.56	\$667.33
4	\$816.67	\$1158.34
6	\$2,222.22	\$2,777.78

### E16AI-14I - MALE END CAP



Size Tube OD	T304	T316L
1	\$11.12	\$31.96
1 1/2	\$11.12	\$31.96
2	\$17.56	\$46.56
2 1/2	\$26.45	\$73.58
3	\$33.34	\$94.60
4	\$60.00	\$170.58
6	\$555.56	\$666.67

# E-LINE FITTINGS

## STAINLESS STEEL FITTINGS PRICE BOOK

### E16AI-15I - FEMALE END CAP



Size Tube OD	T304	T316L
1	\$11.12	\$22.50
1 1/2	\$11.12	\$22.50
2	\$17.56	\$30.50
2 1/2	\$26.45	\$50.20
3	\$33.34	\$65.10
4	\$60.00	\$119.00
6	\$555.56	\$666.67

### GASKETS



Size Tube OD	E40IH	E40IE	E40IT	E40IS	E40IV
1	\$0.67	\$2.67	\$1.33	\$6.89	\$5.33
1 1/2	\$0.67	\$2.56	\$1.44	\$6.89	\$4.89
2	\$0.78	\$2.89	\$1.56	\$8.11	\$6.00
2 1/2	\$0.89	\$3.11	\$1.78	\$8.66	\$6.89
3	\$1.00	\$3.89	\$2.22	\$12.11	\$8.67
4	\$1.56	\$5.56	\$2.89	\$13.22	\$11.33

### E13IU - UNPOLISHED BOLTED CLAMP

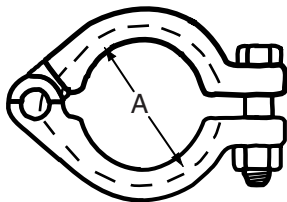

Size Tube OD	T304	T316L
1 & 1 1/2	\$14.67	N/A
2	\$21.89	N/A
2 1/2	\$28.00	N/A
3	\$34.45	N/A
4	\$50.45	N/A
6	\$101.36	N/A

### E13IS - HEAVY DUTY CLAMP

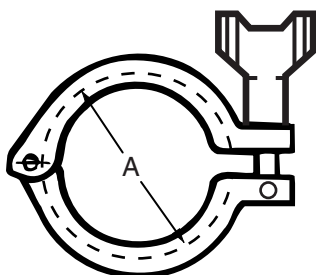

Size Tube OD	T304	T316L
1 & 1 1/2	\$17.91	N/A
2	\$22.23	N/A
2 1/2	\$31.31	N/A
3	\$37.56	N/A
4	\$44.23	N/A
6	\$91.12	N/A

# E-LINE FITTINGS

## STAINLESS STEEL FITTINGS PRICE BOOK

### E311-14I - CONCENTRIC REDUCER MALE X MALE

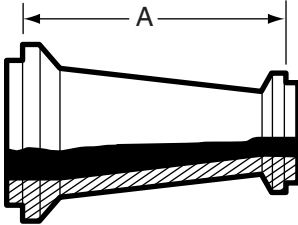

Size Tube OD	T304	T316L
1 1/2 X 1	\$93.89	\$155.56
2 X 1	\$124.44	\$177.78
2 X 1 1/2	\$105.33	\$145.56
2 1/2 X 1 1/2	\$150.00	\$182.22
2 1/2 X 2	\$127.89	\$175.56
3 X 1 1/2	\$200.00	\$277.78
3 X 2	\$166.44	\$248.89
3 x 2 1/2	\$164.22	\$235.56
4 X 2	\$286.67	\$342.22
4 x 2 1/2	\$273.33	\$328.89
4 x 3	\$262.22	\$317.78
6 x 3	\$822.22	\$840.00
6 x 4	\$866.67	\$888.89

### E311-14I-15I - CONCENTRIC REDUCER MALE X FEMALE

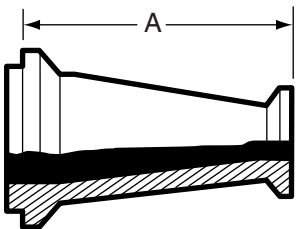

Size Tube OD	T304	T316L
1 1/2 X 1	\$93.89	\$155.56
2 X 1	\$124.44	\$177.78
2 X 1 1/2	\$105.33	\$145.56
2 1/2 X 1 1/2	\$150.00	\$182.22
2 1/2 X 2	\$127.89	\$175.56
3 X 1 1/2	\$200.00	\$277.78
3 X 2	\$166.44	\$248.89
3 x 2 1/2	\$164.22	\$235.56
4 X 2	\$286.67	\$342.22
4 x 2 1/2	\$273.33	\$328.89
4 x 3	\$262.22	\$317.78
6 x 3	\$822.22	\$840.00
6 x 4	\$866.67	\$888.89

# E-LINE FITTINGS

## STAINLESS STEEL FITTINGS PRICE BOOK

### E311-151-141 - CONCENTRIC REDUCER FEMALE X MALE

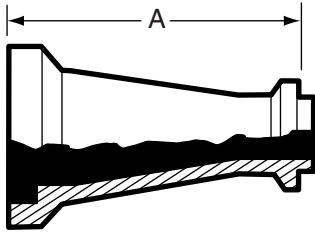

Size Tube OD	T304	T316L
1 1/2 X 1	\$93.89	\$155.56
2 X 1	\$124.44	\$177.78
2 X 1 1/2	\$105.33	\$145.56
2 1/2 X 1 1/2	\$150.00	\$182.22
2 1/2 X 2	\$127.89	\$175.56
3 X 1 1/2	\$200.00	\$277.78
3 X 2	\$166.44	\$248.89
3 x 2 1/2	\$164.22	\$235.56
4 X 2	\$286.67	\$342.22
4 x 2 1/2	\$273.33	\$328.89
4 x 3	\$262.22	\$317.78
6 x 3	\$822.22	\$840.00
6 x 4	\$866.67	\$888.89

### E311-151 - CONCENTRIC REDUCER BOTH ENDS FEMALE

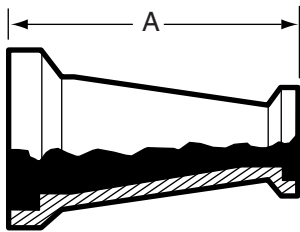

Size Tube OD	T304	T316L
1 1/2 X 1	\$93.89	\$155.56
2 X 1	\$124.44	\$177.78
2 X 1 1/2	\$105.33	\$145.56
2 1/2 X 1 1/2	\$150.00	\$182.22
2 1/2 X 2	\$127.89	\$175.56
3 X 1 1/2	\$200.00	\$277.78
3 X 2	\$166.44	\$248.89
3 x 2 1/2	\$164.22	\$235.56
4 X 2	\$286.67	\$342.22
4 x 2 1/2	\$273.33	\$328.89
4 x 3	\$262.22	\$317.78
6 x 3	\$822.22	\$840.00
6 x 4	\$866.67	\$888.89

### E321-141 - ECCENTRIC REDUCER MALE X MALE

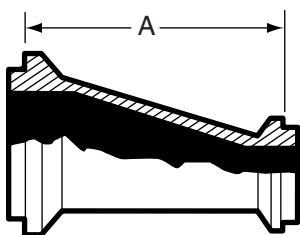

Size Tube OD	T304	T316L
1 1/2 X 1	\$119.89	\$185.56
2 X 1	\$191.00	\$227.22
2 X 1 1/2	\$131.22	\$156.11
2 1/2 X 1 1/2	\$171.56	\$229.33
2 1/2 X 2	\$147.56	\$202.22
3 X 1 1/2	\$193.33	\$294.44
3 X 2	\$188.89	\$255.56
3 x 2 1/2	\$167.11	\$244.44
4 X 2	\$305.56	\$412.00
4 x 2 1/2	\$300.00	\$333.33
4 x 3	\$244.78	\$326.67
6 x 3	\$844.44	\$933.33
6 x 4	\$888.89	\$944.44

# E-LINE FITTINGS

## STAINLESS STEEL FITTINGS PRICE BOOK

### E32I-14I-15I - ECCENTRIC REDUCER MALE X FEMALE

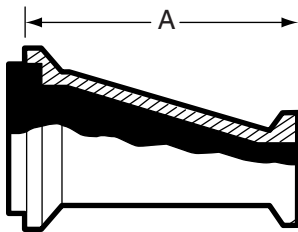

Size Tube OD	T304	T316L
1 1/2 X 1	\$119.89	\$185.56
2 X 1	\$191.00	\$227.22
2 X 1 1/2	\$131.22	\$156.11
2 1/2 X 1 1/2	\$171.56	\$229.33
2 1/2 X 2	\$147.56	\$202.22
3 X 1 1/2	\$193.33	\$294.44
3 X 2	\$188.89	\$255.56
3 x 2 1/2	\$167.11	\$244.44
4 X 2	\$305.56	\$412.00
4 x 2 1/2	\$300.00	\$333.33
4 x 3	\$244.78	\$326.67
6 x 3	\$844.44	\$933.33
6 x 4	\$888.89	\$944.44

### E32I-15I-14I - ECCENTRIC REDUCER FEMALE X MALE

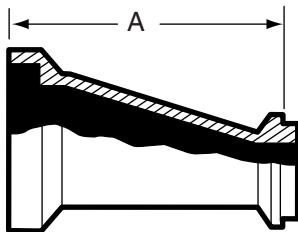

Size Tube OD	T304	T316L
1 1/2 X 1	\$119.89	\$185.56
2 X 1	\$191.00	\$227.22
2 X 1 1/2	\$131.22	\$156.11
2 1/2 X 1 1/2	\$171.56	\$229.33
2 1/2 X 2	\$147.56	\$202.22
3 X 1 1/2	\$193.33	\$294.44
3 X 2	\$188.89	\$255.56
3 x 2 1/2	\$167.11	\$244.44
4 X 2	\$305.56	\$412.00
4 x 2 1/2	\$300.00	\$333.33
4 x 3	\$244.78	\$326.67
6 x 3	\$844.44	\$933.33
6 x 4	\$888.89	\$944.44

### E32I-15I - ECCENTRIC REDUCER BOTH ENDS FEMALE

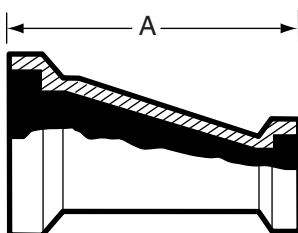

Size Tube OD	T304	T316L
1 1/2 X 1	\$119.89	\$185.56
2 X 1	\$191.00	\$227.22
2 X 1 1/2	\$131.22	\$156.11
2 1/2 X 1 1/2	\$171.56	\$229.33
2 1/2 X 2	\$147.56	\$202.22
3 X 1 1/2	\$193.33	\$294.44
3 X 2	\$188.89	\$255.56
3 x 2 1/2	\$167.11	\$244.44
4 X 2	\$305.56	\$412.00
4 x 2 1/2	\$300.00	\$333.33
4 x 3	\$244.78	\$326.67
6 x 3	\$844.44	\$933.33
6 x 4	\$888.89	\$944.44

# E-LINE FITTINGS

## SCHEDULE 5

### E14WI-5 - SHORT MALE WELDING FERRULE

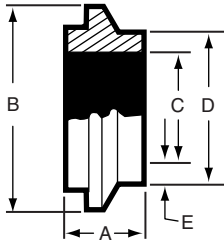

Size Tube OD	T304	T316L
1	N/A	\$57.78
1 1/2	N/A	\$57.78
2	N/A	\$108.89
2 1/2	N/A	\$115.56
3	N/A	\$122.22
4	N/A	\$335.56

### E15WI-5 - SHORT FEMALE WELDING FERRULE

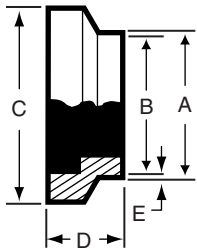

Size Tube OD	T304	T316L
1	N/A	\$57.78
1 1/2	N/A	\$57.78
2	N/A	\$108.89
2 1/2	N/A	\$115.56
3	N/A	\$122.22
4	N/A	\$335.56

### E16AI-14I-5 - MALE END CAP

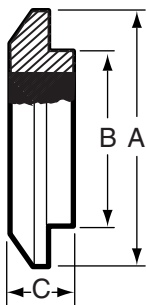

Size Tube OD	T304	T316L
1	POA	POA
1 1/2	POA	POA
2	POA	POA
2 1/2	POA	POA
3	POA	POA
4	POA	POA

### E16AI-15I-5 - FEMALE END CAP

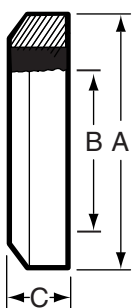

Size Tube OD	T304	T316L
1	POA	POA
1 1/2	POA	POA
2	POA	POA
2 1/2	POA	POA
3	POA	POA
4	POA	POA

# E-LINE FITTINGS

## SCHEDULE 5

### E14WLI-5 - LONG MALE WELDING FERRULE

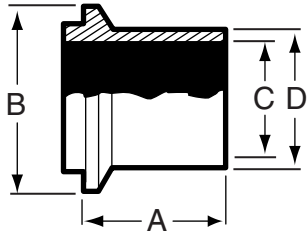

Size Tube OD	T304	T316L
1	POA	POA
1 1/2	POA	POA
2	POA	POA
2 1/2	POA	POA
3	POA	POA
4	POA	POA

### E15WLI-5 - LONG FEMALE WELDING FERRULE

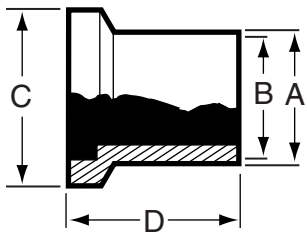

Size Tube OD	T304	T316L
1	POA	POA
1 1/2	POA	POA
2	POA	POA
2 1/2	POA	POA
3	POA	POA
4	POA	POA

### E13IS-5 - HEAVY DUTY CLAMP

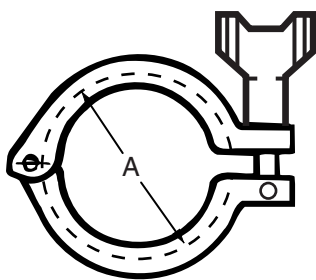

Size Tube OD	T304	T316L
1	\$17.91	N/A
1 1/2	\$20.18	N/A
2	\$31.31	N/A
2 1/2	\$32.76	N/A
3	POA	N/A
4	POA	N/A

### E13IU-5 - CLAMP BOLTED

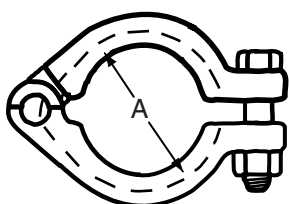

Size Tube OD	T304	T316L
1	\$14.51	POA
1 1/2	\$21.56	POA
2	\$27.64	POA
2 1/2	\$33.24	POA
3	\$66.67	POA
4	\$100.00	POA



# E-LINE FITTINGS

STAINLESS STEEL FITTINGS  
PRICE BOOK

## EQ - LINE

### E14WQ-6L

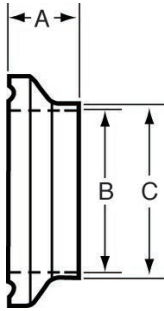

Size Tube OD	T304	T316L
1	N/A	\$28.22
1 1/2	N/A	\$34.33
2	N/A	\$43.00
2 1/2	N/A	\$100.44
3	N/A	\$111.11
4	N/A	\$179.22

### E16AQ-14Q

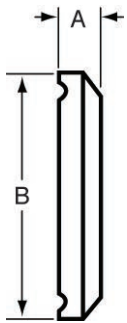

Size Tube OD	T304	T316L
1	N/A	POA
1 1/2	N/A	POA
2	N/A	POA
2 1/2	N/A	POA
3	N/A	POA
4	N/A	POA



## UNPOLISHED TUBE OD FITTINGS....

Unpolished Tube OD Weld Fittings are used in a wide variety of industrial applications where sanitary finishes are not generally required. VNE's tumbled finish presents a consistent uniform appearance.

VNE's Unpolished Weld Fittings are offered in nominal tube sizes 1/2" through 8" in T304 and T316L materials. Uniform wall thickness for 1/2" through 3" sizes measure .065 (16 ga). In 4" size, wall thickness measure .083 (14 ga), 6" and 8" .109 (12 ga).

## TUBE OD FITTING SPECIFICATIONS....

**Size Range:** 1/2" OD through 8" OD

**Materials:** T304  
T316L

**Finish:** Unpolished - Tumbled

## ORDERING SPECIFICATIONS....

**Specify:**

- Quantity
- Product description or Part No.
- Size
- Material Type
- Polish Requirements

## LIMITED WARRANTY....

VNE Corporation products are warranted to be free from defects in material and workmanship for a period of one year from the date of shipment. Any product that proves to be defective shall be repaired or replaced at the option of VNE, providing it has been used as recommended and in strict accordance with recognized piping practices, and that has not been subject to extraordinary service, such as encountered under severe corrosive or abrasive conditions.

VNE makes no warranties, express or implied, other than those listed above.

VNE shall not be liable for any consequential, indirect, incidental or contingent damages.

# UNPOLISHED TUBE OD FITTINGS

## STAINLESS STEEL FITTINGS PRICE BOOK

### V2WC - 90° ELBOW LESS TANGENTS

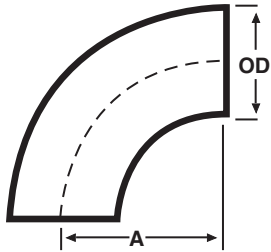

Size Tube OD	T304	T316L
1/2	\$12.56	\$15.60
3/4	\$12.56	\$15.60
1	\$8.42	\$11.02
1 1/4	\$33.11	\$42.22
1 1/2	\$8.89	\$11.20
2	\$11.00	\$13.90
2 1/2	\$20.00	\$24.36
3	\$21.78	\$28.90
4	\$43.31	\$54.60
6	\$207.27	\$245.86
8	\$435.56	\$508.89

### V2S - 90° ELBOW WITH TANGENTS

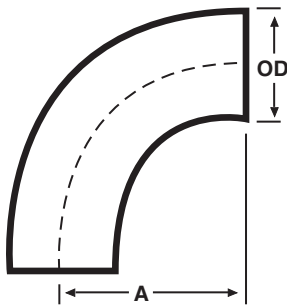

Size Tube OD	T304	T316L
1	\$15.00	\$24.33
1 1/2	\$15.00	\$24.33
2	\$18.33	\$29.89
2 1/2	\$26.89	\$43.67
3	\$41.78	\$68.22
4	\$72.67	\$116.44

### V2WU - 180° U BEND

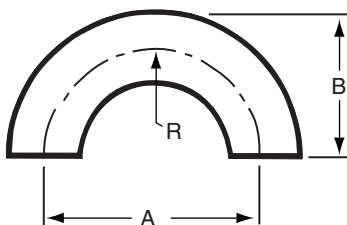

Size Tube OD	T304	T316L
1/2	N/A	\$44.44
3/4	N/A	\$44.44
1	\$46.78	\$52.89
1 1/4	POA	POA
1 1/2	\$53.89	\$62.67
2	\$59.11	\$83.33
2 1/2	\$80.89	\$103.33
3	\$98.44	\$194.44
4	\$153.33	\$250.00
6	\$366.67	POA

# UNPOLISHED TUBE OD FITTINGS

## STAINLESS STEEL FITTINGS PRICE BOOK

### V2WK - 45° ELBOW LESS TANGENTS

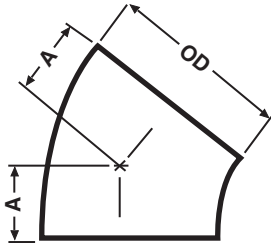

Size Tube OD	T304	T316L
1/2	\$12.56	\$15.60
3/4	\$12.56	\$15.60
1	\$10.44	\$7.71
1 1/4	\$37.78	\$77.78
1 1/2	\$10.44	\$11.20
2	\$10.89	\$13.91
2 1/2	\$17.33	\$22.67
3	\$19.60	\$22.75
4	\$41.74	\$54.60
6	\$165.20	\$220.77
8	\$280.00	\$344.60

### V2KS - 45° ELBOW WITH TANGENTS

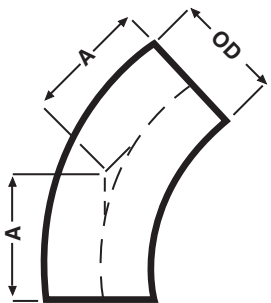

Size Tube OD	T304	T316L
1	\$15.11	\$24.44
1 1/2	\$15.11	\$24.44
2	\$17.78	\$28.67
2 1/2	\$23.33	\$37.89
3	\$29.31	\$47.00
4	\$54.66	\$84.44

### V7W - LONG TEE

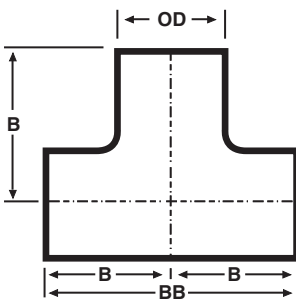

Size Tube OD	T304	T316L
1/2	\$28.56	\$55.56
3/4	\$32.22	\$55.56
1	\$15.56	\$17.47
1 1/4	\$44.44	POA
1 1/2	\$17.22	\$23.33
2	\$21.11	\$26.89
2 1/2	\$30.33	\$41.12
3	\$41.27	\$57.96
4	\$68.11	\$108.89
6	\$483.27	\$495.45
8	\$601.80	\$855.56

### V7WWW - SHORT TEE

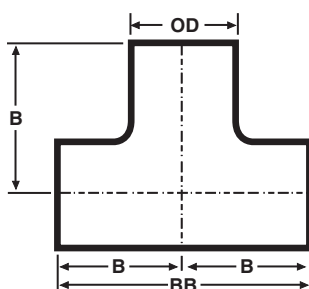

Size Tube OD	T304	T316L
1	\$27.11	\$38.33
1 1/2	\$25.00	\$38.33
2	\$28.67	\$43.78
2 1/2	\$41.56	\$58.11
3	\$59.67	\$91.33
4	\$90.33	\$136.67

# UNPOLISHED TUBE OD FITTINGS

## STAINLESS STEEL FITTINGS PRICE BOOK

### V7WR - REDUCING TEE

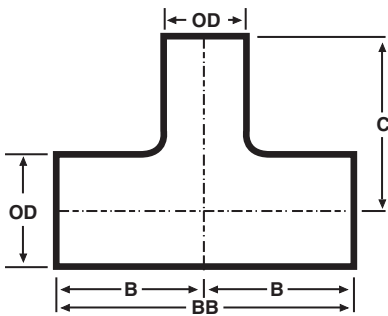

Size Tube OD	T304	T316L
3/4 X 1/2	N/A	\$58.22
1 X 1/2	N/A	\$58.22
1 X 3/4	N/A	\$66.67
1 1/2 X 1/2	N/A	\$61.36
1 1/2 X 3/4	N/A	\$51.70
1 1/2 X 1	\$23.67	\$30.70
1 1/2 X 1 1/4	\$87.78	POA
2 X 1	\$44.22	\$57.33
2 X 1 1/4	\$151.56	POA
2 X 1 1/2	\$27.50	\$38.40
2 1/2 X 1 1/2	\$63.11	\$85.11
2 1/2 X 2	\$43.02	\$69.82
3 X 1 1/2	\$73.00	\$97.50
3 X 2	\$60.26	\$97.50
3 X 2 1/2	\$60.26	\$97.50
4 X 2	\$75.10	\$101.00
4 X 2 1/2	\$75.10	\$101.00
4 X 3	\$75.10	\$101.00
6 X 2	\$464.44	\$531.11
6 X 3	\$375.56	\$531.11
6 X 4	\$375.56	\$305.00

### V9W - CROSS

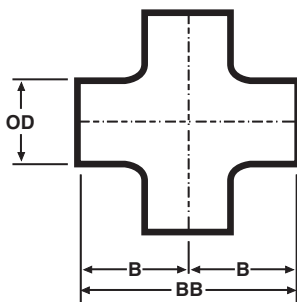

Size Tube OD	T304	T316L
1/2	N/A	\$102.00
3/4	N/A	\$102.00
1	\$52.78	\$57.44
1 1/4	POA	POA
1 1/2	\$57.89	\$72.78
2	\$72.33	\$92.89
2 1/2	\$153.33	\$163.33
3	\$153.33	\$257.78
4	\$242.22	\$328.89
6	\$911.11	\$1155.56

# UNPOLISHED TUBE OD FITTINGS

## STAINLESS STEEL FITTINGS PRICE BOOK

### V14WA - TYPE A STUB END WITH GROOVES

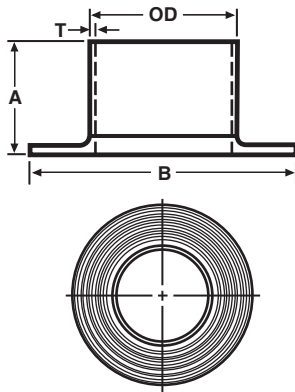

Size Tube OD	T304	T316L
1/2	N/A	\$77.78
3/4	N/A	\$84.45
1	N/A	\$71.00
1 1/4	N/A	POA
1 1/2	N/A	\$72.30
2	N/A	\$83.20
2 1/2	N/A	\$109.00
3	N/A	\$112.00
4	N/A	\$167.78
6	N/A	\$666.67

### V16W - WELD CAP

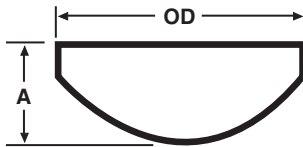

Size Tube OD	T304	T316L
1/2	N/A	\$34.44
3/4	N/A	\$34.44
1	\$9.56	\$16.20
1 1/4	\$13.78	\$28.89
1 1/2	\$10.89	\$16.80
2	\$14.11	\$17.20
2 1/2	\$17.78	\$19.40
3	\$20.22	\$20.44
4	\$26.67	\$28.70
6	\$186.67	\$202.22
8	\$333.33	\$466.67

### 19WB - MALE NPT X WELD ADAPTER

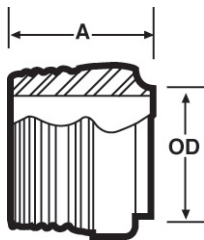

Size Tube OD	T304	T316L
1/2	N/A	\$17.50
3/4	N/A	\$17.50
1	\$10.35	\$17.03
1 1/4	N/A	\$65.56
1 1/2	\$14.40	\$24.91
2	\$21.02	\$34.06
2 1/2	\$37.91	\$59.00
3	\$48.98	\$67.27
4	\$98.42	\$118.00
6	\$311.11	\$466.67

### 22WB - FEMALE NPT X WELD ADAPTER

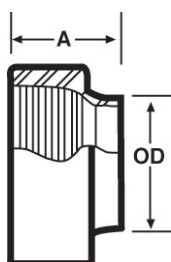

Size Tube OD	T304	T316L
1/2	N/A	\$46.67
3/4	N/A	\$46.67
1	\$25.33	\$32.33
1 1/4	N/A	\$57.22
1 1/2	\$27.78	\$39.00
2	\$30.00	\$42.33
2 1/2	\$52.33	\$69.22
3	\$66.11	\$81.78
4	\$99.89	\$135.00

# UNPOLISHED TUBE OD FITTINGS

## STAINLESS STEEL FITTINGS PRICE BOOK

### V28WA - 45° LATERAL

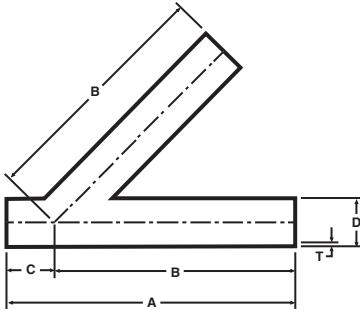

Size Tube OD	T304	T316L
1	\$137.56	\$177.78
1 1/2	\$177.78	\$186.67
2	\$183.33	\$196.67
2 1/2	\$238.89	\$257.78
3	\$266.67	\$316.67
4	\$320.00	\$350.00
6	\$777.78	\$1146.67

### V28WB - TRUE Y

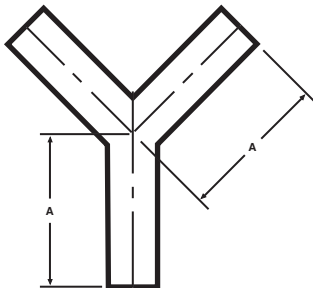

Size Tube OD	T304	T316L
1	\$146.67	\$138.89
1 1/2	\$150.00	\$177.78
2	\$183.33	\$196.67
2 1/2	\$238.89	\$257.78
3	\$266.67	\$316.67
4	\$294.44	\$350.00
6	\$1111.12	\$1288.89

### V31W - CONCENTRIC REDUCER

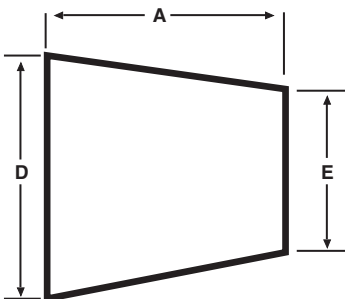

Size Tube OD	T304	T316L
3/4 X 1/2	N/A	\$44.51
1 X 1/2	N/A	\$93.33
1 X 3/4	N/A	\$40.00
1 1/2 X 1/2	N/A	\$97.13
1 1/2 X 3/4	N/A	\$97.13
1 1/2 X 1	\$12.96	\$16.40
1 1/2 X 1 1/4	\$70.00	\$73.34
2 X 1	\$24.20	\$36.90
2 X 1 1/4	\$73.33	\$77.78
2 X 1 1/2	\$14.60	\$18.70
2 1/2 X 1 1/2	\$32.22	\$36.44
2 1/2 X 2	\$17.44	\$20.80
3 X 1 1/2	\$50.27	\$74.91
3 X 2	\$23.56	\$31.00
3 X 2 1/2	\$22.89	\$28.20
4 X 2	\$72.53	\$82.89
4 X 2 1/2	\$66.22	\$82.89
4 X 3	\$24.30	\$40.00
6 X 3	\$282.22	\$300.00
6 X 4	\$282.22	\$300.00

# UNPOLISHED TUBE OD FITTINGS

## STAINLESS STEEL FITTINGS PRICE BOOK

### V32W - ECCENTRIC REDUCER

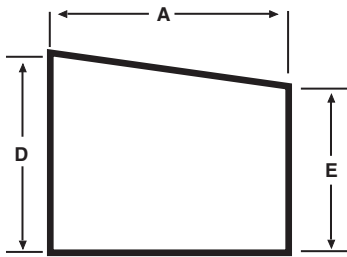

Size Tube OD	T304	T316L
3/4 X 1/2	N/A	\$64.00
1 X 1/2	N/A	\$64.00
1 X 3/4	N/A	\$64.00
1 1/2 X 1/2	N/A	\$99.71
1 1/2 X 3/4	N/A	\$99.71
1 1/2 X 1	\$23.70	\$31.56
1 1/2 x 1 1/4	POA	\$80.00
2 X 1	\$56.89	\$75.78
2 X 1 1/4	POA	POA
2 X 1 1/2	\$20.30	\$22.22
2 1/2 X 1 1/2	\$43.33	\$57.33
2 1/2 X 2	\$26.90	\$28.00
3 X 1 1/2	\$64.80	\$125.00
3 X 2	\$40.22	\$55.56
3 X 2 1/2	\$52.50	\$71.91
4 X 2	\$108.47	\$143.00
4 X 2 1/2	\$76.00	\$113.00
4 X 3	\$43.90	\$70.67
6 X 3	\$371.11	\$362.22
6 X 4	\$371.11	\$362.22

### E38SL - SLIP ON FLANGE

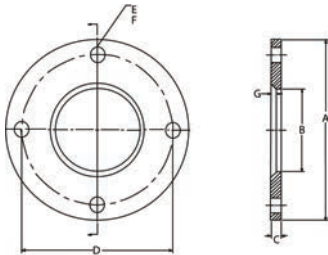

Size Tube OD	T304	T316L
1	\$44.07	N/A
1 1/2	\$58.16	N/A
2	\$70.91	N/A
2 1/2	\$101.00	N/A
3	\$120.00	N/A
4	\$153.42	N/A

### V14RH - 6L B/W Rubber Hose Barb Blank #1

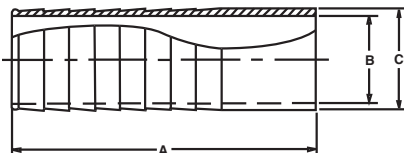

Size Tube OD	T304	T316L
1/4	N/A	POA
5/16	N/A	\$37.48
3/8	N/A	\$18.11
1/2	N/A	\$18.11
5/8	N/A	\$28.41
3/4	N/A	\$28.41
1	N/A	\$23.70
1 1/4	N/A	\$23.70
1 1/2	N/A	\$23.70
2	N/A	\$25.80
2 1/2	N/A	\$25.80
3	N/A	\$28.00
4	N/A	\$47.12
6	N/A	\$137.12





## European Din Connections....

VNE's European Din Connections are available in Inch-Size Tube O.D. Weld Neck. Now inch size tubing can be utilized on projects requiring Din Connections, where in the past metric tubing had to be purchased.

VNE stocks welding ferrules - both male (threaded) and female (plain) - along with the standard DIN nut and gasket to complete the union in T304. T316 ferrules and other metric fittings are available upon request.

## EUROPEAN DIN SPECIFICATIONS....

**Product:** Din Connection x Din Weld Connection  
Fully Metric Din Fittings

**Size Range:** Din 10 - Din 100

**Materials:** T304 & T316

**Finish:** #7 ID / OD Polish

## ORDERING SPECIFICATIONS....

25-KURZ-NW10  
(Din male threaded ferrule size 10, T304)

35-KURZ-6-NW10  
(Din female plain ferrule size 10, T316)

## EUROPEAN DIN SPECIFICATIONS....

**Product:** Din Connection X Inch Weld  
Connection

**Size Range:** 1" - 4"

**Materials:** T304 & T316

**Finish:** #7 ID / OD Polish

## ORDERING SPECIFICATIONS....

2SRW-25 X 1.0  
(Din male threaded ferrule x size 1" weld con-  
nection, T304)

3SRW-6-25X1.0  
(Din female plain ferrule x size 1" weld con-  
nection, T316)

# MISCELLANEOUS

## STAINLESS STEEL FITTINGS PRODUCT CATALOG

### 4-NUT-NW-(SIZE) (304 ONLY)

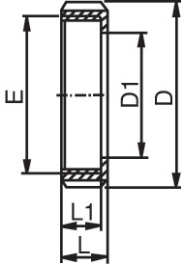

Size (Din)	T304	T316
10	\$30.00	N/A
15	\$32.89	N/A
20	\$33.12	N/A
25	\$33.78	N/A
32	\$34.23	N/A
40	\$37.78	N/A
50	\$41.12	N/A
65	\$60.00	N/A
75/3	\$103.56	N/A
80	\$111.12	N/A
100	\$133.34	N/A
125	\$173.34	N/A
150	\$493.34	N/A
200	\$666.67	N/A

### 5-RING NW (SIZE) BUNA

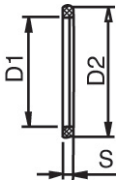

Size (Din)	T304	T316
10	\$5.00	N/A
15	\$5.23	N/A
20	\$5.56	N/A
25	\$6.23	N/A
32	\$6.45	N/A
40	\$6.89	N/A
50	\$7.78	N/A
65	\$10.45	N/A
7 5/3	\$12.23	N/A
80	\$12.89	N/A
100	\$16.67	N/A
125	\$21.12	N/A
150	\$21.12	N/A

# MISCELLANEOUS

## STAINLESS STEEL FITTINGS PRODUCT CATALOG

### 5A-RING NW (SIZE) EPDM

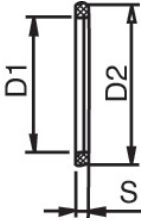

Size (Din)	T304	T316
10	\$5.00	N/A
15	\$5.23	N/A
20	\$5.56	N/A
25	\$6.23	N/A
32	\$6.45	N/A
40	\$6.89	N/A
50	\$7.78	N/A
65	\$10.45	N/A
7 5/3	\$12.23	N/A
80	\$12.89	N/A
100	\$16.67	N/A
125	\$21.12	N/A
150	\$21.12	N/A

### 5B- RING NW (SIZE) SILICONE

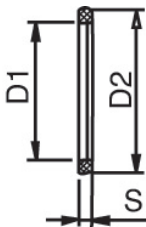

Size (Din)	T304	T316
10	\$5.00	N/A
15	\$5.23	N/A
20	\$5.56	N/A
25	\$6.23	N/A
32	\$6.45	N/A
40	\$6.89	N/A
50	\$7.78	N/A
65	\$10.45	N/A
7 5/3	\$12.23	N/A
80	\$12.89	N/A
100	\$16.67	N/A
125	\$21.12	N/A
150	\$21.12	N/A

# MISCELLANEOUS

## STAINLESS STEEL FITTINGS PRODUCT CATALOG

### 2S-KURZ-NW(SIZE ) DIN MALE THREAD X DIN WELD FERRULE T304 / T316

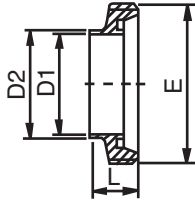

Size (Din)	T304	T316
10	\$24.67	\$28.89
15	\$27.56	\$31.12
20	\$34.00	\$37.78
25	\$35.56	\$41.12
32	\$39.34	\$43.89
40	\$40.45	\$48.89
50	\$43.89	\$52.23
65	\$50.45	\$55.56
75	\$86.23	\$97.78
100	\$127.78	\$144.45
125	\$222.23	\$266.67
150	\$320.00	\$388.89

### 3S-KURZ-NW(SIZE) DIN FEMALE X DIN WELD FERRULE T304 / T316

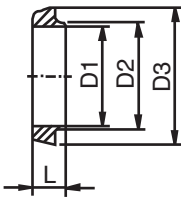

Size (Din)	T304	T316
10	\$16.45	\$20.56
15	\$18.23	\$23.34
20	\$23.12	\$24.45
25	\$24.45	\$27.78
32	\$26.23	\$28.89
40	\$27.78	\$31.67
50	\$28.89	\$37.23
65	\$36.89	\$41.12
80	\$64.23	\$72.23
100	\$98.23	\$111.12
125	\$146.67	\$222.23
150	\$422.23	\$295.56

### 74-CAP NW(SIZE) (304 & 316)

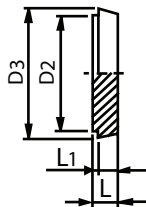

Size (Din)	T304	T316
10	\$18.67	\$34.23
15	\$20.00	\$36.00
20	\$24.45	\$38.00
25	\$28.89	\$48.89
32	\$37.12	\$60.00
40	\$42.00	\$71.12
50	\$59.78	\$80.00
65	\$67.78	\$96.00
80	\$98.23	\$113.34
100	\$164.00	\$197.78
125	\$266.67	\$420.00
150	\$377.78	\$500.00

## 2SRW (SIZE) DIN MALE THREAD X INCH WELD FERRULES T304 / T316

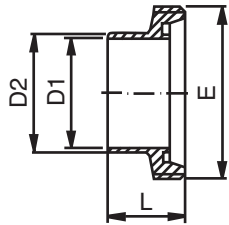

Size (Din)	T304	T316
25 X 1.0	\$25.23	\$36.67
40 X 1.5	\$30.67	\$44.45
50 X 2.0	\$34.67	\$47.78
65 X 2.5	\$52.89	\$77.78
75 X 3.0	\$79.67	\$113.34
80 X 3.0	N/A	\$377.22
100 X 4.0	\$130.00	\$188.89

## 3SRW (SIZE) DIN FEMALE X INCH WELD FERRULES T304 / T316

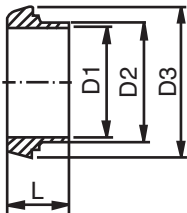

Size (Din)	T304	T316
25 X 1.0	\$17.12	\$23.78
40 X 1.5	\$20.89	\$28.67
50 X 2.0	\$24.45	\$33.34
65 X 2.5	\$39.78	\$55.56
75 X 3.0	\$68.89	\$100.00
80 X 3.0	N/A	\$272.44
100 X 4.0	\$93.89	\$133.34



## Pipe Hangers....

Pipe Hangers are available in Tube OD sizes. All hangers are hexagonal shape with either rubber grommets or PVC inserts. Hangers are also available with a 3/8" coupling.

Larger tube OD and pipe sizes are available upon special request.

## PIPE HANGER SPECIFICATIONS....

**Product:** Tube OD Piping Hangers

**Size Range:** 1/2" through 6" sizes

**Materials:** T304 - Hangers  
Rubber / Viton - Grommets  
PVC - Sleeve insert

## ORDERING SPECIFICATIONS....

**Specify:**

- Quantity
- Product description or Part No.
- Size
- Material Type

# MISCELLANEOUS

## STAINLESS STEEL FITTINGS PRODUCT CATALOG

### PIPE HANGERS

#### E24

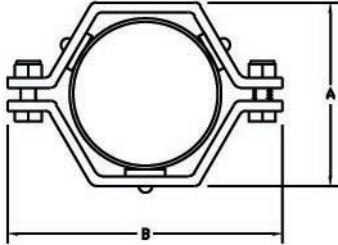

Size Tube OD	T304	T316
1/2	\$6.63	N/A
3/4	\$6.63	N/A
1	\$6.96	N/A
1 1/2	\$7.48	N/A
2	\$8.99	N/A
2 1/2	\$10.27	N/A
3	\$11.60	N/A
4	\$15.10	N/A
6	\$45.63	N/A

#### E24C

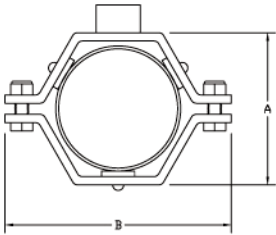

Size Tube OD	T304	T316
1/2	\$20.75	N/A
3/4	\$20.80	N/A
1	\$20.89	N/A
1 1/2	\$21.00	N/A
2	\$21.30	N/A
2 1/2	\$23.44	N/A
3	\$23.60	N/A
4	\$29.52	N/A
6	\$47.89	N/A

#### E24PVC

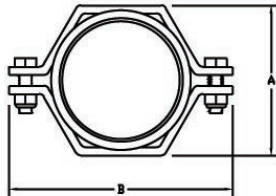

Size Tube OD	T304	T316
1/2	\$5.40	N/A
3/4	\$5.40	N/A
1	\$7.19	N/A
1 1/2	\$7.90	N/A
2	\$9.47	N/A
2 1/2	\$11.03	N/A
3	\$12.40	N/A
4	\$16.28	N/A
6	\$60.39	N/A